

Innovations Fall/Winter 2015/16

# A CUT ABOVE

*Showcasing the innovative new collection  
of crystal shapes, colors and effects  
from Swarovski for Fall/Winter 2015/16*



ATELIER MUNSTEINER FOR SWAROVSKI  
VISION ROUND & FANCY STONES, DESIGNER EDITION



NEW COLOR SMOKY MAUVE  
NEW EFFECT CRYSTAL PARADISE SHINE



STARLET FLAT BACK  
CURVY FLAT BACK



PAVÉ THREAD RING



CRYSTAL FINE MESH



QUEEN BAGUETTE PENDANT  
CROSS BEAD

# Content

09	Why Swarovski
11	Product Overview
15	Designer Editions
19	Round Stones
20	Fancy Stones & Settings
24	Beads
30	BeCharmed & Pavé
39	Crystal Pearls
41	Pendants
48	Flat Backs No Hotfix
49	Flat Backs Hotfix
52	Sew-On Articles
56	Transfers
63	Synthetics Hotfix
86	Buttons, Fasteners & Zippers
93	Metal Trimmings
105	Crystal Mesh
110	Cupchains & Findings
112	Application Aids



## EXCELLENCE, THROUGH INNOVATION AND ORIGIN

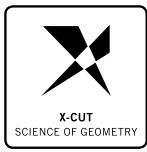

**X-CUT**  
Advanced optical measurement and high-precision manufacturing deliver premium cuts characterized by unmatched brilliance.

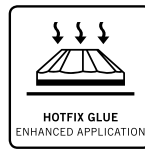

**HOTFIX GLUE**  
The variable temperatures at which Hotfix glue can be activated enable the application of crystals on a broad range of textiles.



**PLATINUM PRO**  
With its new advanced foiling technique, Swarovski has set a new standard in the lifespan of crystals.



**CRYSTALS - MADE IN AUSTRIA**  
The combination of innovation with sustainability and respect for individual wellbeing means that quality is always assured.

## PREMIUM, BY SERVICE AND DESIGN



**DESIGN SERVICE**  
Throughout its global network of Design Centers, Swarovski offers exceptional service provided by the industry's best creative talent.



**GLOBAL SERVICE**  
Swarovski's Global Service Network provides customers with dedicated personal assistance on a local level.



**APPLICATION SERVICE**  
A comprehensive range of application services means customers benefit from the extensive experience of leading international experts, as well as internal specialists.



**DESIGNER EDITIONS**  
Creative collaborations with top designers result in exclusive cuts and unique designs for Swarovski crystal.

## COMPLIANCE, WITH INTEGRITY



**ADVANCED CRYSTAL**  
Swarovski's patented lead-free\* formula has changed the DNA of crystal while still offering the same sparkle, dependability, and variety for which Swarovski is famous.



**CLEAR**  
Regular legal monitoring of chemical requirements and reasonable testing provide customers with the comfort of trust in Swarovski's products.

\*Crystal glass and all other materials containing 0.009% lead or less.



**OEKO-TEX**  
Oeko-Tex® Standard 100 Class II (direct contact with skin) certification creates confidence in chemical safety of textile applications.



## Seal your success

Be part of our exclusive Ingredient Branding program

# Product Overview

## NEW CRYSTAL ELEMENTS

### Designer Editions: Vision Round & Fancy Stones



**1681**  
12, 16 mm



**1681/S**  
12, 16 mm



**4481**  
12, 16 mm



**4481/S**  
12, 16 mm



**4681**  
14, 18 mm



**4681/S**  
14, 18 mm

### Fancy Stones & Settings



**4503** Tapered Baguette  
Fancy Stone  
4x2, 6.3x2.4 mm

### Beads



**5378** Cross Bead  
14, 18 mm



**5748** Arrow Bead  
12, 16 mm

### BeCharmed & Pavé



**81 304**  
14 mm



**81 403**  
14 mm



**81 504**  
14 mm



**84 501** BeCharmed  
Pavé Ceramics  
14 mm



**85 001**  
Pavé Thread Ring  
14.5, 16.5, 18.5 mm

### Pendants



**6465** Queen Baguette  
Pendant  
13.5x6, 25x7, 38x10 mm



**6724** Sun Pendant  
12, 19, 33 mm



**6724/G** Sun Pendant  
party frosted  
12, 19, 33 mm

### Flat Backs Hotfix



**2494** Starlet Flat Back  
6, 8, 10.5 mm



**2540** Curvy Flat Back  
7x5.5, 9x7, 12x9.5 mm

### Sew-on Articles



**3259** Heart  
Sew-on Stone  
12, 16 mm

### Flat Backs No Hotfix



**2494** Starlet Flat Back  
6, 8, 10.5 mm



**2540** Curvy Flat Back  
7x5.5, 9x7, 12x9.5 mm

### Buttons, Fasteners & Zippers



**3011** Clover Crystal  
Button  
10, 12, 14 mm

## NEW FORWARD-INTERGRATED ELEMENTS

### Synthetics Hotfix

### Transfers & Synthetics

### Crystal Medley

### Bandings with...

### Crystaltex Cabochon Bandings

### Buttons, Fasteners & Zippers



**1795/140** Crystal Fine  
Rocks Jeans Button

### Crystal Mesh



**40 600, 40 601**  
Crystal Fine Mesh

### Metal Trimmings



**55 300, 55 301**  
Flat Back Banding

### Cupchains & Findings



**37 E02**  
Catch-free Stretch  
Bracelet







# Product Overview

## NEW EFFECT



















Crystal Paradise  
Shine  
(001 PARSH)





### Round Stones

 <b>1028</b> PP 9, 10, 11, 13	 <b>5051</b> 8x6, 10x8 mm
 <b>1088</b> PP 14, 18, 21, 24, 31, 32 SS 24, 29, 34, 39	 <b>5052</b> 6, 8 mm
 <b>1122</b> SS 39, 47 12, 14 mm	 <b>5053</b> 6, 8 mm



### Fancy Stones & Settings

 <b>4120</b> 6x4, 8x6, 14x10, 18x13 mm	 <b>5055</b> 8x6, 10x8 mm
 <b>4127</b> 30x22 mm	 <b>5056</b> 10x6, 12x8 mm
 <b>4228</b> 6x3, 8x4, 10x5, 15x7 mm	 <b>5328</b> 3, 4, 5, 6 mm
 <b>4320</b> 6x4, 8x6, 14x10, 18x13 mm	 <b>5378</b> 14, 18 mm
 <b>4327</b> 30x20 mm	 <b>5541</b> 11, 15 mm
 <b>4428</b> 2, 3, 4, 6, 8 mm	 <b>5542</b> 8, 11 mm
 <b>4470</b> 10, 12 mm	 <b>5601</b> 4, 6, 8 mm
 <b>4568</b> 8x6, 14x10, 18x13, 27x18 mm	 <b>5747</b> 12x6, 16x8 mm







### Beads





 <b>5000</b> 3, 4, 6, 8, 10 mm	 <b>5750</b> 13, 19 mm
 <b>5028/4</b> 6, 8, 10 mm	 <b>5754</b> 6, 8, 10 mm
 <b>5040</b> 4, 6, 8 mm	

### BeCharmed & Pavé

 <b>5928</b> 14 mm STEEL	 <b>5929</b> 14 mm STEEL
 <b>5948</b> 14 mm STEEL	

### Pendants

 <b>6000</b> 11x5.5, 13x6.5, 15x7.5 mm	 <b>6010</b> 11x5.5, 13x6.5 mm
 <b>6040</b> 20, 30, 40 mm	 <b>6041</b> 18, 28, 38 mm
 <b>6090</b> 16x11, 22x15 mm	 <b>6106</b> 16, 22, 28 mm
 <b>6128</b> 8, 10, 12 mm	

 <b>6228</b> 10.3x10, 14.4x14, 18x17.5, 28 mm	 <b>6328</b> 6, 8 mm
 <b>6428</b> 6, 8, 12 mm	 <b>6465</b> 13.5x6, 25x7, 38x10 mm





 <b>6628</b> 8, 12, 16 mm
---------------------------------------------------------------------------------------------------------------

 <b>6724</b> 12, 19, 33 mm
----------------------------------------------------------------------------------------------------------------

 <b>6724/G</b> 12, 19, 33 mm
------------------------------------------------------------------------------------------------------------------

 <b>6764</b> 19, 23, 28 mm
----------------------------------------------------------------------------------------------------------------





### Flat Backs No Hotfix

 <b>2058</b> SS 5, 7, 9	 <b>2088</b> SS 12, 16, 20, 30, 34
 <b>2494</b> 6, 8, 10.5 mm	 <b>2540</b> 7x5.5, 9x7, 12x9.5 mm
 <b>2858</b> 6x4.5, 9x6.5, 12x8.5 mm	



### Flat Backs Hotfix

 <b>2038</b> SS 6, 8, 10	 <b>2078</b> SS 12, 16, 20, 34
 <b>2494</b> 6, 8, 10.5 mm	 <b>2540</b> 7x5.5, 9x7, 12x9.5 mm
 <b>2858</b> 6x4.5, 9x6.5, 12x8.5 mm	

### Sew-on Articles

 <b>3188</b> 3, 4, 5 mm	 <b>3200</b> 10, 12, 14 mm
 <b>3258</b> 12x8.5, 16x11.5 mm	 <b>3259</b> 12, 16 mm
 <b>3288</b> 8, 10, 12 mm	





### Transfers

 <b>1360</b> (with art. 1028) PP 7, 12	 <b>1360</b> (with art. 1088) PP 17
--------------------------------------------------------------------------------------------------------------------------------	-----------------------------------------------------------------------------------------------------------------------------

### Buttons, Fasteners & Zippers

 <b>3011</b> 10, 12, 14 mm
--------------------------------------------------------------------------------------------------------------------

### Metal Trimmings

 <b>53 001, 53 005, 53 006, 53 008</b> SS 29, 34, 39 PP 24	 <b>53 500, 53 501, 53 502</b> 4, 6, 8 mm
 <b>53 100, 53 102</b> SS 12, 16	 <b>53 200, 53 203</b> PP 31 SS 29
 <b>53 301, 53 302, 53 303, 53 304</b> SS 10, 16, 20, 34	

# Product Overview

## NEW COLOR

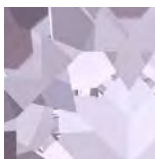

Smoky Mauve  
(265)

### Designer Editions: Vision Round & Fancy Stones

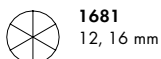

**1681**  
12, 16 mm



**4481**  
12, 16 mm



**4681**  
14, 18 mm

### Round Stones



**1028**  
PP 9, 10, 11, 13



**1088**  
PP 14, 18, 21, 24, 31, 32  
SS 24, 29, 34, 39



**1122**  
SS 39, 47  
12, 14 mm

### Fancy Stones & Settings



**4120**  
6x4, 8x6, 14x10,  
18x13 mm



**4127**  
30x22 mm



**4228**  
6x3, 8x4, 10x5,  
15x7 mm



**4320**  
6x4, 8x6, 14x10,  
18x13 mm



**4327**  
30x20 mm



**4428**  
2, 3, 4, 6, 8 mm



**4470**  
10, 12 mm

### Beads



**5000**  
3, 4, 6, 8 mm



**5040**  
4, 6, 8 mm



**5328**  
3, 4, 5, 6 mm



**5378**  
14, 18 mm



**5541**  
11, 15 mm



**5542**  
8, 11 mm



**5748**  
12, 16 mm



**5754**  
6, 8, 10 mm

### Pendants



**6010**  
11x5.5, 13x6.5 mm



**6106**  
16, 22 mm



**6228**  
10.3x10, 14.4x14 mm



**6428**  
6, 8 mm

### Flat Backs No Hotfix



**2058**  
SS 5, 7, 9



**2088**  
SS 12, 16, 20, 30, 34



**2494**  
6, 8, 10.5 mm



**2540**  
7x5.5, 9x7, 12x9.5 mm

### Flat Backs Hotfix



**2038**  
SS 6, 8, 10



**2078**  
SS 12, 16, 20, 34



**2494**  
6, 8, 10.5 mm



**2540**  
7x5.5, 9x7, 12x9.5 mm

### Sew-on Articles



**3188**  
3, 4, 5 mm



**3200**  
10, 12, 14 mm



**3259**  
12, 16 mm



**3288**  
8, 10, 12 mm

### Transfers



**1360** (with art. 1028)  
PP 7, 12



**1360** (with art. 1088)  
PP 17

### Crystal Inspirations Collection

**13 068**  
**13 070**  
**13 072**

### Buttons, Fasteners & Zippers



**1791/120**  
17 mm



**1792/100**  
17 mm



**1811/100**  
12 mm



**1811/120**  
15 mm

### Metal Trimmings



**52 000, 52 001**  
SS 18



**52 500, 52 501**  
PP 24



**55 000, 55 001**  
SS 20



**55 500, 55 501**  
SS 12



**53 001, 53 005,**  
**53 006, 53 008**  
SS 29, 34, 39  
PP 24



**53 500, 53 501,**  
**53 502**  
4, 6, 8 mm



**53 100, 53 102**  
SS 12, 16



**53 200, 53 203**  
PP 31  
SS 29

### Crystal Mesh



**40 000, 40 001**  
PP 21



**40 200, 40 201**  
PP 21



**40 400, 40 401**  
PP 14

# Product Overview

## NEW CRYSTAL PEARL COLOR



Crystal Iridescent  
Purple Pearl  
(001 943)

### BeCharmed & Pavé



**5890**  
14 mm STEEL

### Crystal Pearls



**5810**  
3, 4, 5, 6, 8, 10, 12 mm



**5817**  
6, 8, 10 mm



**5821**  
11x8 mm



**5860**  
10, 12, 14, 16 mm



**5811**  
10, 12, 14, 16 mm



**5818**  
4, 6, 8, 10 mm



**5840**  
6, 8, 10, 12, 14 mm

## LINE EXTENSIONS

### Crystal Patina on



**5750**  
13, 19 mm

### New Colors & Effects for Crystal Fabric

Crystal Antique Pink  
Crystal Chrome

### New Colors & Effects for Crystal Rocks

Mint Alabaster  
Rose Alabaster  
Turquoise  
White Alabaster  
Chrysolite Opal  
Cyclamen Opal  
Rose Water Opal  
White Opal  
Crystal Moonlight  
Crystal Chrome

### New Colors & Effects for Crystal Fine Rocks

Mint Alabaster  
Rose Alabaster  
Turquoise  
White Alabaster  
Chrysolite Opal  
Cyclamen Opal  
Rose Water Opal  
White Opal  
Crystal Moonlight  
Crystal Chrome

### Rose Gold Plating for Buttons, Fasteners & Metal Trimmings

## NEW APPLICATION AIDS

### Chaton Sieves



9030/001



9030/002

## EXTENDED ASSORTMENT

To provide even more assortment variety in color, effect and sizes, we now offer selected items as "Extended Assortment". For these items we guarantee availability for at least 12 months after launch date under regular ordering conditions (1 packing unit). "Extended Assortment" articles are marked with "□" within the respective product matrix. Please check on available quantities with our Customer Service or online via our e-commerce website [B2B.ECOMMERCE.SWAROVSKI.COM](https://B2B.ECOMMERCE.SWAROVSKI.COM). Additional product information can also be found on our business website [SWAROVSKI.COM/PROFESSIONAL](https://SWAROVSKI.COM/PROFESSIONAL).

ATELIER MUNSTEINER FOR SWAROVSKI

Vision Round Stone and Vision Fancy Stones

The new Vision Designer Edition marks the first ever collaboration between Swarovski and Atelier Munsteiner, a German design house renowned for its multi-award-winning gemstone cuts, fine jewelry, and sculptures. The family-owned company's third-generation master craftsmen have drawn upon many years of experience to develop this stunning crystal innovation exclusively for Swarovski.

The Vision Designer Edition combines the uncomplicated appeal of simple cuts with the playfulness of mirrored reflections. These ingeniously crafted design elements bring to mind frozen water, with mysteriously encapsulated air bubbles forming a perfectly geometrical, flower-like shape within the crystal. It is available in three of the most popular shapes for Jewelry and Accessories - the round, square, and hexagon - offering endless design possibilities and making it ideal for use in Glamorous and Progressive creations.

It's the subtlety in the simplicity that makes this Designer Edition truly "VISIONARY."

1681 Vision Round Stone <sup>NEW!</sup>

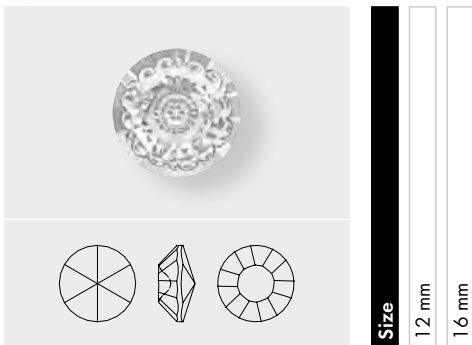

Size  
12 mm  
16 mm

Crystal

Crystal F (001)

Colors

Plain Colors

Aquamarine F (202)

Erinite F (360)

Light Colorado Topaz F (246)

Light Peach F (362)

Light Siam F (227)

Rose F (209)

Smoky Mauve F (265) <sup>NEW!</sup>

Tanzanite F (539)

Crystal Effects

Transparent Effects

Crystal Antique Pink F (001 ANTP)

Crystal Astral Pink F (001 API)

Crystal Blue Shade F (001 BLSH)

Crystal Golden Shadow F (001 GSHA)

Crystal Luminous Green F (001 LUMG)

Crystal Silver Night F (001 SINI)

1681/S <sup>NEW!</sup>

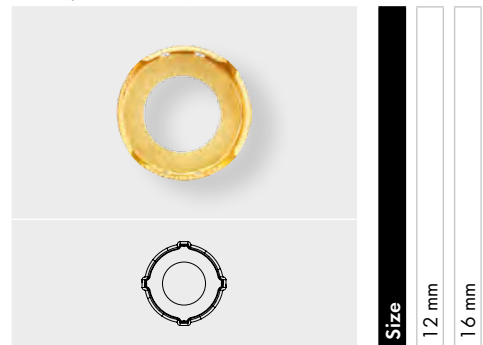

Size  
12 mm  
16 mm

Ring/Hole, Back Configuration

00 C = No ring/hole, closed

H2 O = 4 holes/2 each side, open



00 C



H2 O

4481 Vision Square Fancy Stone <sup>NEW!</sup>

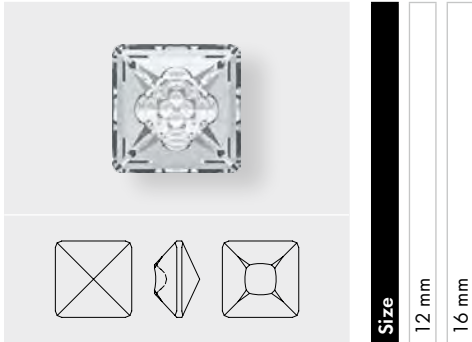

Size  
12 mm  
16 mm

**Crystal**

Crystal F (001)

**Colors**

**Plain Colors**

Aquamarine F (202)

Erinite F (360)

Light Colorado Topaz F (246)

Light Peach F (362)

Light Siam F (227)

Rose F (209)

Smoky Mauve F (265) <sup>NEW!</sup>

Tanzanite F (539)

**Crystal Effects**

**Transparent Effects**

Crystal Antique Pink F (001 ANTP)

Crystal Astral Pink F (001 API)

Crystal Blue Shade F (001 BLSH)

Crystal Golden Shadow F (001 GSHA)

Crystal Luminous Green F (001 LUMG)

Crystal Silver Night F (001 SINI)

4481/S <sup>NEW!</sup>

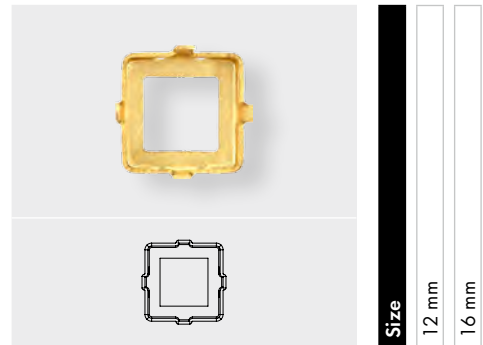

Size  
12 mm  
16 mm

**Ring/Hole, Back Configuration**

00 C = No ring/hole, closed

H2 O = 4 holes/2 each side, open





4681 Vision Hexagon Fancy Stone <sup>NEW!</sup>

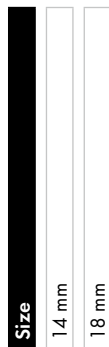
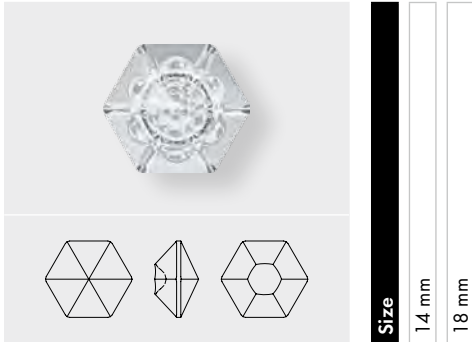

**Crystal**

Crystal F (001)

**Colors**

**Plain Colors**

Aquamarine F (202)

Erinite F (360)

Light Colorado Topaz F (246)

Light Peach F (362)

Light Siam F (227)

Rose F (209)

Smoky Mauve F (265) <sup>NEW!</sup>

Tanzanite F (539)

**Crystal Effects**

**Transparent Effects**

Crystal Antique Pink F (001 ANTP)

Crystal Astral Pink F (001 API)

Crystal Blue Shade F (001 BLSH)

Crystal Golden Shadow F (001 GSHA)

Crystal Luminous Green F (001 LUMG)

Crystal Silver Night F (001 SINI)

4681/S <sup>NEW!</sup>

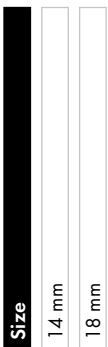
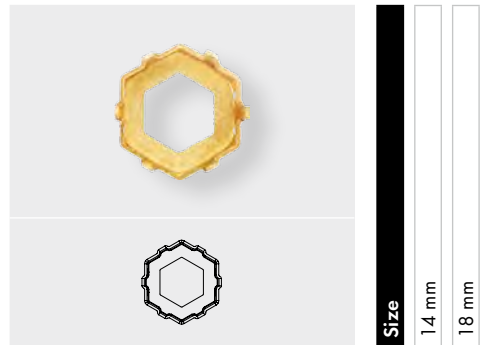

**Ring/Hole, Back Configuration**

00 C = No ring/hole, closed

H2 O = 4 holes/2 each side, open



00 C



H2 O

## Vision Round Stone

---

### APPLICATION ADVICE

If applying the article to a solid material, a cavity should be created. Cavities can be produced either by drilling or by milling. It is recommended to create cavities with a flat bottom to protect the crystals' foiling and to achieve a good bond.

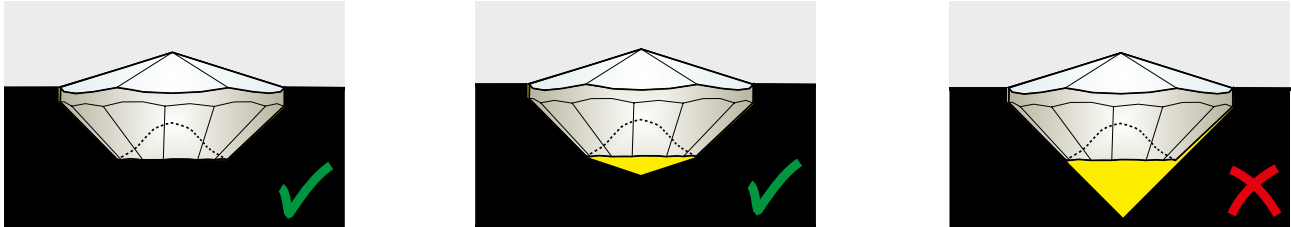

For detailed information concerning cavity dimensions and technical drawings, please contact your local Swarovski sales organization.

Please check the surface tension of the carrier material before gluing. Detailed information concerning surface tension, pre-cleaning and possible adhesives can be found in the Application Manual and on our business website [SWAROVSKI.COM/PROFESSIONAL](http://SWAROVSKI.COM/PROFESSIONAL).

---

### CARE INSTRUCTIONS

The care instructions for the Vision Round Stone are the same as those that apply to the Round Stone assortment. For detailed information, please refer to the Application Manual and our business website [SWAROVSKI.COM/PROFESSIONAL](http://SWAROVSKI.COM/PROFESSIONAL).

## Vision Hexagon Fancy Stone & Vision Square Fancy Stone

---

### APPLICATION ADVICE

If applying the article to a solid material, a cavity should be created. Cavities can be produced by milling. It is recommended to create cavities with a flat bottom to protect the crystals' foiling and to achieve a good bond.

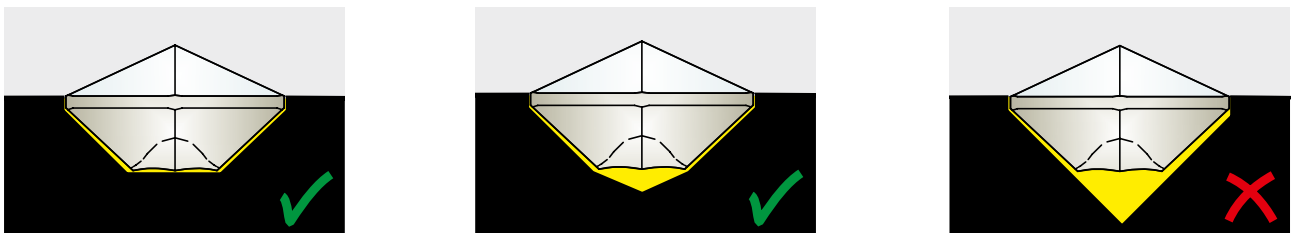

For detailed information concerning cavity dimensions and technical drawings, please contact your local Swarovski sales organization.

Please check the surface tension of the carrier material before gluing. Detailed information concerning surface tension, pre-cleaning and possible adhesives can be found in the Application Manual and on our business website [SWAROVSKI.COM/PROFESSIONAL](http://SWAROVSKI.COM/PROFESSIONAL).

---

### CARE INSTRUCTIONS

The care instructions for the Vision Fancy Stones are the same as those that apply to the Fancy Stone assortment. For detailed information, please refer to the Application Manual and our business website [SWAROVSKI.COM/PROFESSIONAL](http://SWAROVSKI.COM/PROFESSIONAL).

# Round Stones

## 1028 XILLION Chaton

	Size	PP 9	PP 10	PP 11	PP 13
<b>Colors</b>					
<b>Plain Colors</b>					
Smoky Mauve F (265)	NEW!	■	■	■	■
<b>Crystal Effects</b>					
<b>Transparent Effects</b>					
Crystal Paradise Shine F (001 PARSH)	NEW!	■	■	■	■

## 1088 XIRIUS Chaton

	Size	PP 14	PP 18	PP 21	PP 24	PP 31	PP 32	SS 24	SS 29	SS 34	SS 39
<b>Colors</b>											
<b>Plain Colors</b>											
Smoky Mauve F (265)	NEW!	■	■	■	■	■	■	■	■	■	■
<b>Crystal Effects</b>											
<b>Transparent Effects</b>											
Crystal Paradise Shine F (001 PARSH)	NEW!	■	■	■	■	■	■	■	■	■	■

# Round Stones

## 1122 Rivoli Chaton

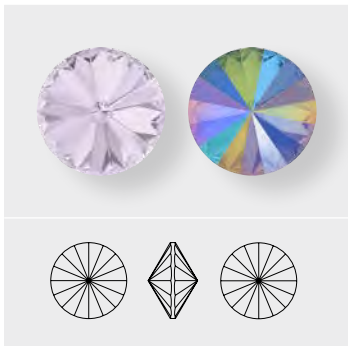

Size	SS 39	SS 47	12 mm	14 mm
<b>Colors</b>				
<b>Plain Colors</b>				
Smoky Mauve F (265)	NEW!			
<b>Crystal Effects</b>				
<b>Transparent Effects</b>				
Crystal Paradise Shine F (001 PARSH)	NEW!			

# Fancy Stones & Settings

## 4120

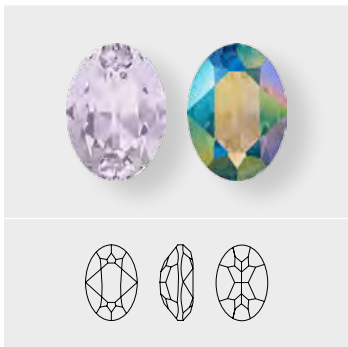

Size	6x4 mm	8x6 mm	14x10 mm	18x13 mm
<b>Colors</b>				
<b>Plain Colors</b>				
Smoky Mauve F (265)	NEW!			
<b>Crystal Effects</b>				
<b>Transparent Effects</b>				
Crystal Paradise Shine F (001 PARSH)	NEW!			

## 4127

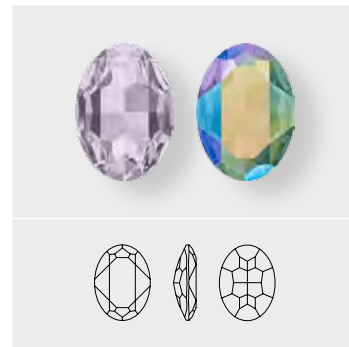

Size	30x22 mm
<b>Colors</b>	
<b>Plain Colors</b>	
Smoky Mauve F (265)	NEW!
<b>Crystal Effects</b>	
<b>Transparent Effects</b>	
Crystal Paradise Shine F (001 PARSH)	NEW!

# Fancy Stones & Settings

## 4228 XILLION Navette Fancy Stone

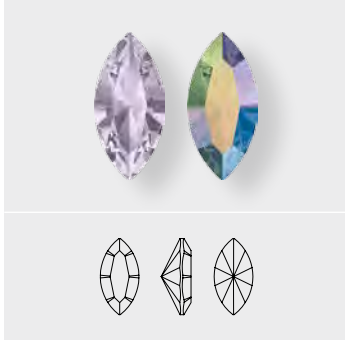

**Size** 6x3, 8x4, 10x5, 15x7 mm

4228

Size	6x3 mm	8x4 mm	10x5 mm	15x7 mm
Colors				
Plain Colors				
Crystal Effects				
Transparent Effects				
NEW!	■	■	■	■
NEW!	■	■	■	■

## 4320

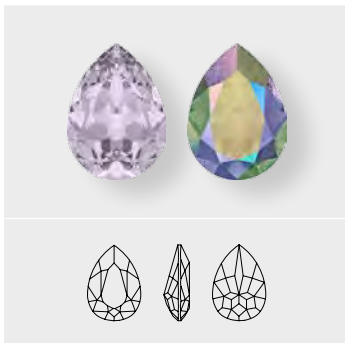

Size	6x4 mm	8x6 mm	14x10 mm	18x13 mm
Colors				
Plain Colors				
Crystal Effects				
Transparent Effects				
NEW!	■	■	■	■
NEW!	■	■	■	■

## 4327

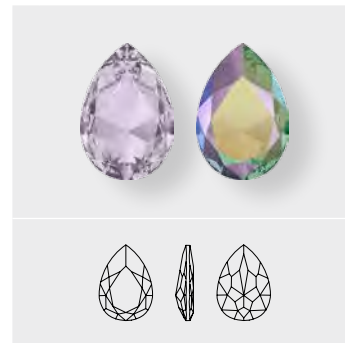

Size	30x20 mm
Colors	
Plain Colors	
Crystal Effects	
Transparent Effects	
NEW!	■
NEW!	■

# Fancy Stones & Settings

4428

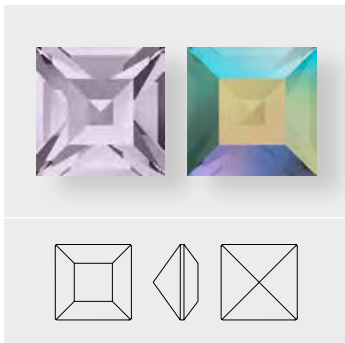

Size 2 mm

4428 XILION Square Fancy Stone

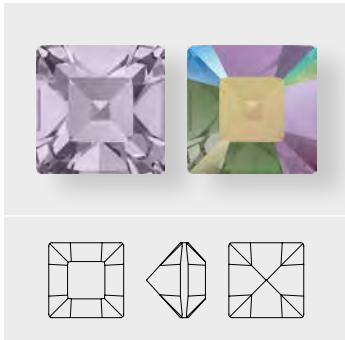

Size 3, 4 mm

4428 XILION Square Fancy Stone

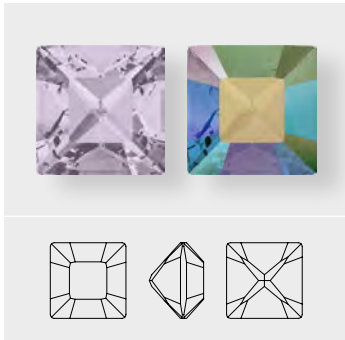

Size 5, 6, 8 mm

4428

Size	2 mm	3 mm	4 mm	6 mm	8 mm
Colors					
Plain Colors					
Smoky Mauve F (265)	NEW!	■	■	■	■
Crystal Effects					
Transparent Effects					
Crystal Paradise Shine F (001 PARSH)	NEW!	■	■	■	■

# Fancy Stones & Settings

4470

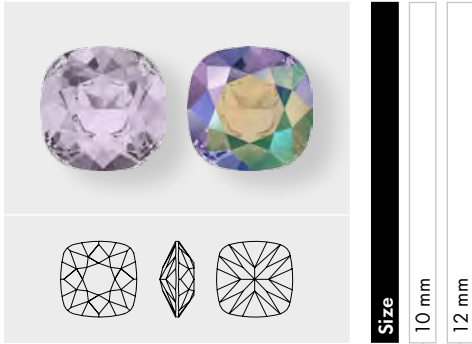

**Colors**

**Plain Colors**

Smoky Mauve F (265) NEW!

**Crystal Effects**

**Transparent Effects**

Crystal Paradise Shine F (001 PARSH) NEW!

**Size**  
10 mm  
12 mm

4568 Cushion Fancy Stone



**Crystal Effects**

**Transparent Effects**

Crystal Paradise Shine F (001 PARSH) NEW!

**Size**  
8x6 mm  
14x10 mm  
18x13 mm  
27x18 mm

4503 Tapered Baguette Fancy Stone NEW!

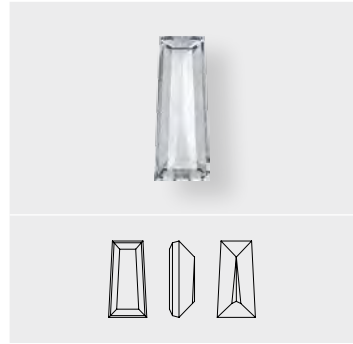

**Crystal**

Crystal F (001)

**Colors**

**Plain Colors**

Amethyst F (204)

Black Diamond F (215)

Dark Moss Green F (260)

Jet (280)

Light Peach F (362)

Light Rose F (223)

Montana F (207)

Smoked Topaz F (220)

**Crystal Effects**

**Transparent Effects**

Crystal AB F (001 AB)

Crystal Golden Shadow F (001 GSHA)

**Metallic Effects**

Crystal Metallic Blue F (001 METBL)

Crystal Rose Gold F (001 ROGL)

**Size**  
4x2 mm  
6.3x2.4 mm

# Beads

## 5000

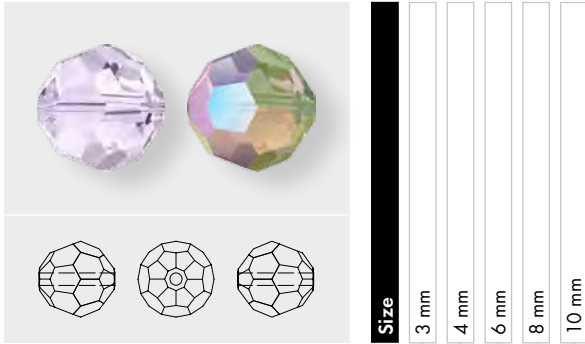

### Colors

#### Plain Colors

Smoky Mauve (265) NEW!

#### Crystal Effects

#### Transparent Effects

Crystal Paradise Shine (001 PARSH) NEW!

Size	3 mm	4 mm	6 mm	8 mm	10 mm
Smoky Mauve (265)	NEW!				
Crystal Paradise Shine (001 PARSH)	NEW!				

## 5028/4 Crystal Globe Bead

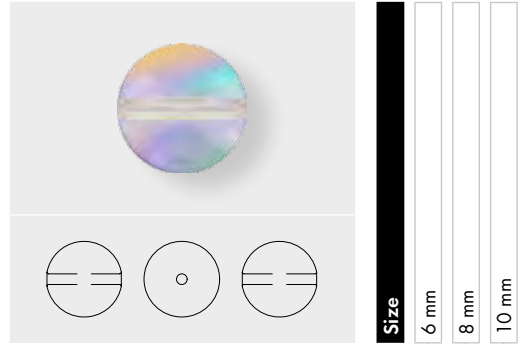

### Crystal Effects

#### Transparent Effects

Crystal Paradise Shine (001 PARSH) NEW!

Size	6 mm	8 mm	10 mm
Crystal Paradise Shine (001 PARSH)	NEW!		

## 5040 Briolette Bead

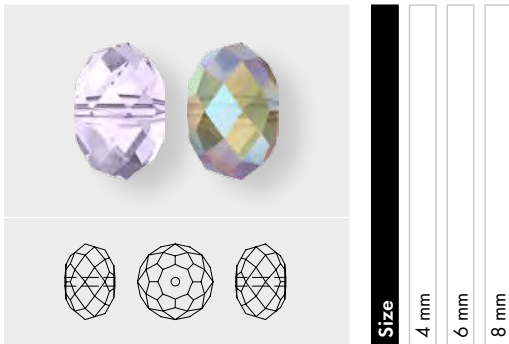

### Colors

#### Plain Colors

Smoky Mauve (265) NEW!

#### Crystal Effects

#### Transparent Effects

Crystal Paradise Shine (001 PARSH) NEW!

Size	4 mm	6 mm	8 mm
Smoky Mauve (265)	NEW!		
Crystal Paradise Shine (001 PARSH)	NEW!		

## 5051 Mini Oval Bead

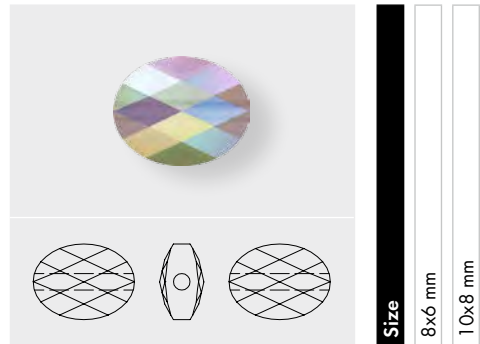

### Crystal Effects

#### Transparent Effects

Crystal Paradise Shine (001 PARSH) NEW!

Size	8x6 mm	10x8 mm
Crystal Paradise Shine (001 PARSH)	NEW!	



# Beads

### 5052 Mini Round Bead

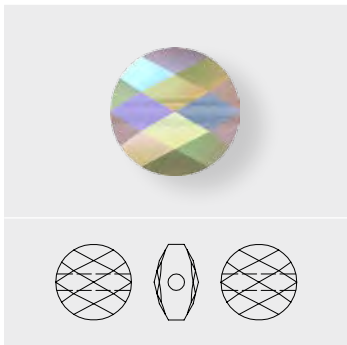

**Size**  
6 mm  
8 mm

**Crystal Effects**  
**Transparent Effects**

 Crystal Paradise Shine (001 PARSH) NEW!

### 5053 Mini Square Bead

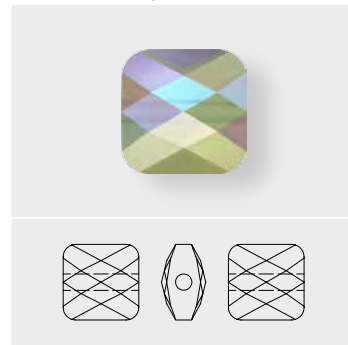

**Size**  
6 mm  
8 mm

**Crystal Effects**  
**Transparent Effects**

 Crystal Paradise Shine (001 PARSH) NEW!

### 5054 Mini Rhombus Bead

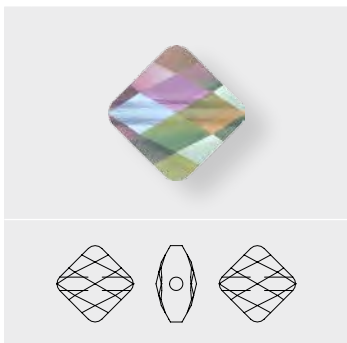

**Size**  
6 mm  
8 mm

**Crystal Effects**  
**Transparent Effects**

 Crystal Paradise Shine (001 PARSH) NEW!

### 5055 Mini Rectangle Bead

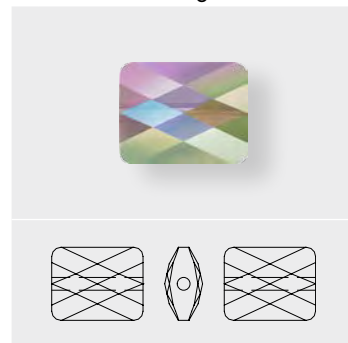

**Size**  
8x6 mm  
10x8 mm

**Crystal Effects**  
**Transparent Effects**

 Crystal Paradise Shine (001 PARSH) NEW!

# Beads

## 5056 Mini Drop Bead

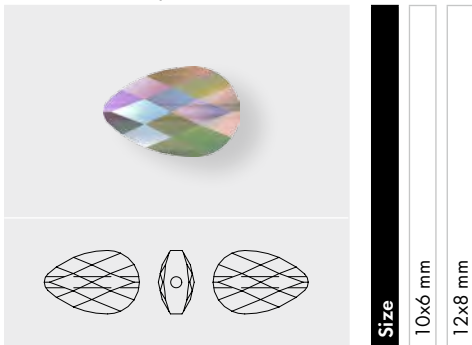

### Crystal Effects

### Transparent Effects

 Crystal Paradise Shine (001 PARSH) NEW!



## 5328 XILION Bead

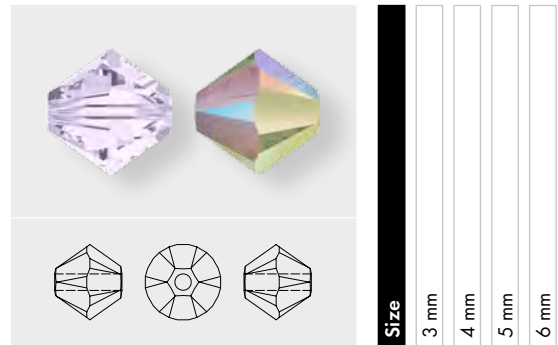

### Colors

### Plain Colors

 Smoky Mauve (265) NEW!

### Crystal Effects

### Transparent Effects

 Crystal Paradise Shine (001 PARSH) NEW!

 Crystal Paradise Shine 2x (001 PARSH2) NEW!

### Color Effects

### Transparent Effects

 Smoky Mauve AB (265 AB) NEW!

 Smoky Mauve AB 2x (265 AB2) NEW!



# Beads

## 5378 Cross Bead <sup>NEW!</sup>

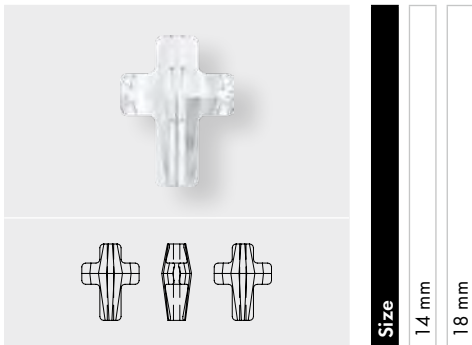

Size

14 mm

18 mm

### Crystal

Crystal (001)

### Colors

### Plain Colors

Jet (280)

Light Turquoise (263)

Smoky Mauve (265) <sup>NEW!</sup>

### Crystal Effects

### Transparent Effects

Crystal AB (001 AB)

Crystal Astral Pink (001 API)

Crystal Golden Shadow (001 GSHA)

Crystal Lilac Shadow (001 LISH)

Crystal Paradise Shine (001 PARSH) <sup>NEW!</sup>

Crystal Silver Night (001 SINI)

Crystal Silver Night 2x (001 SINI2)

Crystal Silver Shade (001 SSHA)

### Metallic Effects

Crystal Iridescent Green (001 IRIG)

Crystal Metallic Light Gold 2x (001 MLG2)

Crystal Rose Gold 2x (001 ROGL2)

### Crystal Patina

Crystal Black Patina (001 BLAPA)

Crystal Gold Patina (001 GOLPA)

Crystal Rose Patina (001 ROSPA)

Crystal Silver Patina (001 SILPA)

Crystal White Patina (001 WHIPA)

## 5541 Dome Bead large

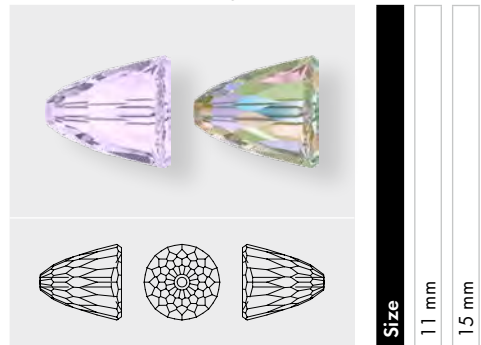

Size

11 mm

15 mm

### Colors

### Plain Colors

Smoky Mauve (265) <sup>NEW!</sup>

### Crystal Effects

### Transparent Effects

Crystal Paradise Shine (001 PARSH) <sup>NEW!</sup>

## 5542 Dome Bead small

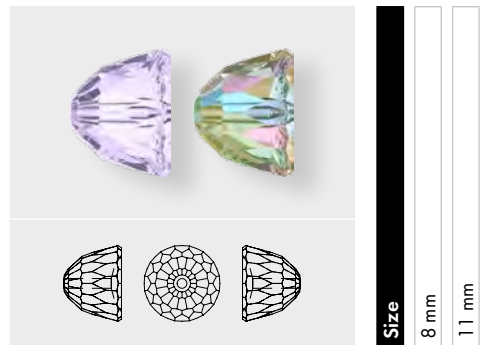

Size

8 mm

11 mm

### Colors

### Plain Colors

Smoky Mauve (265) <sup>NEW!</sup>

### Crystal Effects

### Transparent Effects

Crystal Paradise Shine (001 PARSH) <sup>NEW!</sup>

# Beads

## 5601

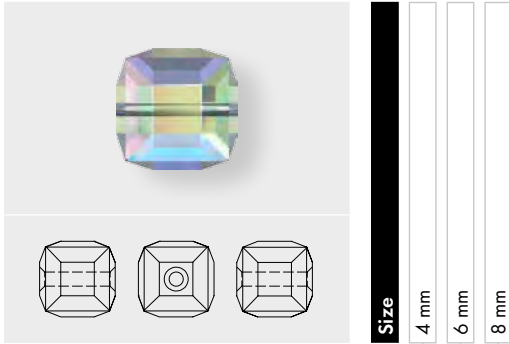

### Crystal Effects

### Transparent Effects

Crystal Paradise Shine B (001 PARSHB) NEW!

## 5747 Double Spike Bead

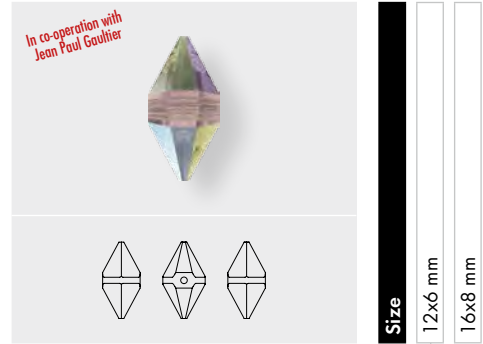

### Crystal Effects

### Transparent Effects

Crystal Paradise Shine (001 PARSH) NEW!

## 5748 Arrow Bead NEW!

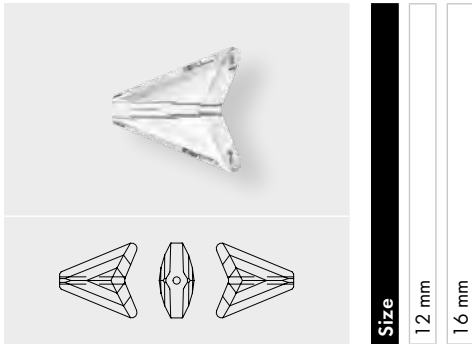

### Crystal

Crystal (001)

### Colors

### Plain Colors

Jet (280)

Light Turquoise (263)

Smoky Mauve (265) NEW!

### Crystal Effects

### Transparent Effects

Crystal AB (001 AB)

Crystal Astral Pink (001 API)

Crystal Golden Shadow (001 GSHA)

Crystal Paradise Shine (001 PARSH) NEW!

Crystal Red Magma (001 REDM)

Crystal Silver Night (001 SINI)

Crystal Silver Night 2x (001 SINI2)

Crystal Silver Shade (001 SSHA)

## 5748

### Metallic Effects

Crystal Iridescent Green (001 IRIG)

Crystal Metallic Light Gold 2x (001 MLG2)

Crystal Rose Gold 2x (001 ROGL2)

### Crystal Patina

Crystal Black Patina (001 BLAPA)

Crystal Gold Patina (001 GOLPA)

Crystal Rose Patina (001 ROSPA)

Crystal Silver Patina (001 SILPA)

Crystal White Patina (001 WHIPA)

# Beads

## 5750 Skull Bead

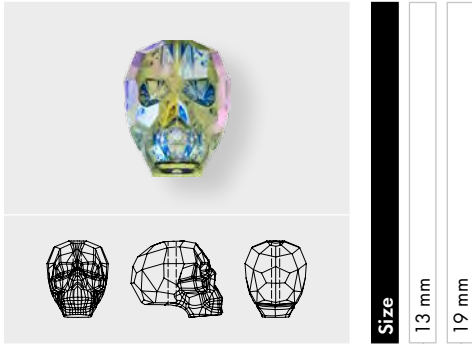

Size

13 mm

19 mm

### Crystal Effects

#### Transparent Effects

Crystal Paradise Shine (001 PARSH) NEW!

#### Crystal Patina

Crystal Black Patina (001 BLAPA) NEW! NEW!

Crystal Gold Patina (001 GOLPA) NEW! NEW!

Crystal Rose Patina (001 ROSPA) NEW! NEW!

Crystal Silver Patina (001 SILPA) NEW! NEW!

Crystal White Patina (001 WHIPA) NEW! NEW!

## 5754 Butterfly Bead

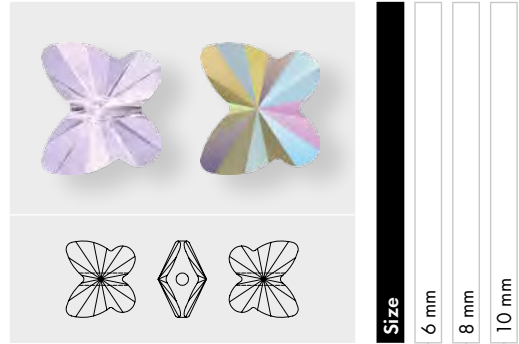

Size

6 mm

8 mm

10 mm

### Colors

#### Plain Colors

Smoky Mauve (265) NEW!

#### Crystal Effects

#### Transparent Effects

Crystal Paradise Shine (001 PARSH) NEW!

# BeCharmed & Pavé

**5890** Crystal BeCharmed Pearl



**Colors**

● Crystal Iridescent Purple Pearl (001 943) NEW!

**Size**

14 mm STEEL

**5928** BeCharmed Helix Bead



**Crystal Effects**

**Transparent Effects**

● Crystal Paradise Shine (001 PARSH) NEW!

**Size**

14 mm STEEL

**5929** BeCharmed Fortune Bead



**Crystal Effects**

**Transparent Effects**

● Crystal Paradise Shine (001 PARSH) NEW!

**Size**

14 mm STEEL

**5948** BeCharmed Briolette Bead

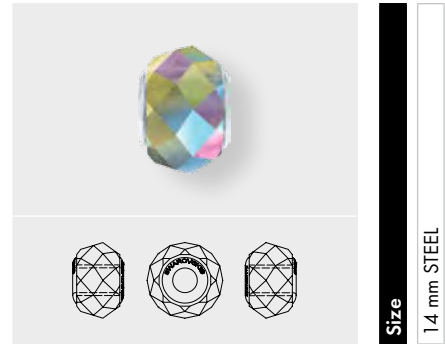

**Crystal Effects**

**Transparent Effects**

● Crystal Paradise Shine (001 PARSH) NEW!

**Size**

14 mm STEEL

**81 304, 81 403, 81 504 BECHARMED PAVÉ MEDLEY**

A mix of different stone sizes and articles are available in a wide color range and can be easily combined with many different kinds of BeCharmed products.

**ARTICLE EXPLANATION**

**81 304** BeCharmed Pavé Medley

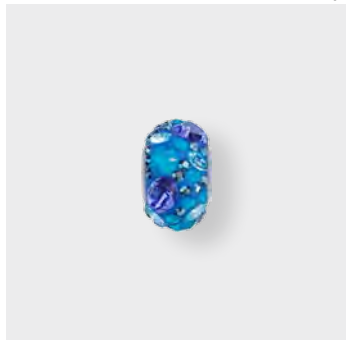

<b>S</b>	14 mm	
<b>M</b>	12 PCS	<b>100%</b>

**81 403** BeCharmed Pavé Medley



<b>S</b>	14 mm	
<b>M</b>	12 PCS	<b>100%</b>

**81 504** BeCharmed Pavé Medley

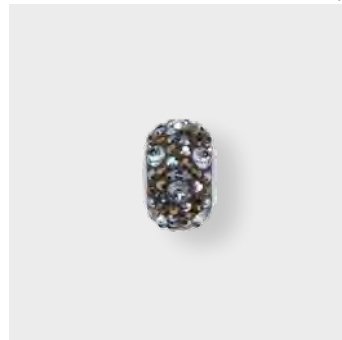

<b>S</b>	14 mm	
<b>M</b>	12 PCS	<b>100%</b>

<b>81 304</b>	<b>S</b>	<b>M</b>	<b>100%</b>
Article number	Size	Minimum Order Quantity in pieces (PCS)	Documentation size in %

**EXPLANATION OF "COLOR COMBINATIONS"**

All mentioned color combinations are pre-established in terms of

- Color of crystal
  - Color of Ceralun™
- and are not modifiable.

For ordering BeCharmed Pavé please follow the ordering example systematic below.

**ORDERING EXAMPLE & PRODUCT VARIETY EXPLANATION**

<b>1</b>	<b>81 304</b>	<b>12</b>	<b>209 208 213 259</b>
Metal Core	Article number	Color of Ceralun™	Color of crystals
1 Stainless Steel		Please see the respective product matrix for all available code references	Please see the respective product matrix for all available code references.

# BeCharmed & Pavé

## 81 304 BeCharmed Pavé Medley <sup>NEW!</sup>

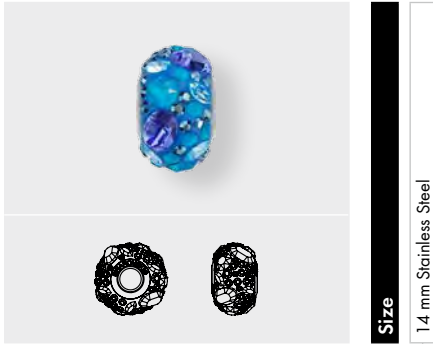

Size

14 mm Stainless Steel

### Colors

- Rose (209)
  - Siam (208)
  - Jonquil (213)
  - Tangerine (259)
  - Shining Curry (12)
- 
- Aquamarine (202)
  - Sapphire (206)
  - Carribbean Blue Opal (394)
  - Crystal Metallic Blue (001 METBL)
  - Shining Blue (37)
- 
- Black Diamond (215)
  - Jet Hematite (280 HEM)
  - Crystal Silver Shade (001 SSHA)
  - Greige (284)
  - Grey (19)
- 
- Crystal Golden Shadow (001 GSHA)
  - Rose (209)
  - Ruby (501)
  - Crystal Antique Pink (001 ANTP)
  - Burgundy (29)
- 
- Topaz (203)
  - Smoked Topaz (220)
  - Light Peach (362)
  - Light Grey Opal (383)
  - Shining Lilac (41)
- 
- Emerald (205)
  - Chrysolite Opal (294)
  - Light Peach (362)
  - Erinite (360)
  - Pearl Jade (40)

## 81 403 BeCharmed Pavé Medley <sup>NEW!</sup>



Size

14 mm Stainless Steel

### Colors

- Amethyst (204)
  - Aquamarine (202)
  - Air Blue Opal (285)
  - Turquoise (38)
- 
- Smoked Topaz (220)
  - Light Topaz (226)
  - Crystal Bronze Shade (001 BRSH)
  - Antique Gold (35)
- 
- Light Amethyst (212)
  - Air Blue Opal (285)
  - Dark Indigo (288)
  - Dark Blue (15)
- 
- Light Siam (227)
  - Hyacinth (236)
  - Light Topaz (226)
  - Red (21)
- 
- Tangerine (259)
  - Light Siam (227)
  - Vintage Rose (319)
  - Shining Curry (12)
- 
- Sapphire (206)
  - Pacific Opal (390)
  - Peridot (214)
  - Pearl Jade (40)



## 81 504 BeCharmed Pavé Medley <sup>NEW!</sup>

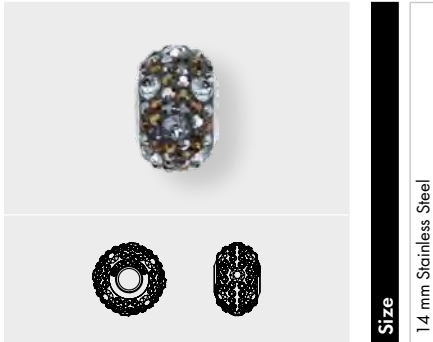

### Colors

- [Crystal Silver Night \(001 SINI\)](#)
- [Jet Hematite \(280 HEM\)](#)
- [Jet Nut \(280 NUT\)](#)
- [Jet \(280\)](#)
- [Black \(02\)](#)

- [Crystal Bermuda Blue \(001 BBL\)](#)
- [Dark Indigo \(288\)](#)
- [Cyclamen Opal \(398\)](#)
- [Amethyst \(204\)](#)
- [Shining Lilac \(41\)](#)

- [Crystal Golden Shadow \(001 GSHA\)](#)
- [Light Grey Opal \(383\)](#)
- [Light Smoked Topaz \(221\)](#)
- [Silk \(391\)](#)
- [Shining Curry \(12\)](#)

- [Crystal Metallic Blue \(001 METBL\)](#)
- [Denim Blue \(266\)](#)
- [Air Blue Opal \(285\)](#)
- [Crystal Blue Shade \(001 BLSH\)](#)
- [Cadetblue \(43\)](#)

- [Crystal Rose Gold \(001 ROGL\)](#)
- [Light Peach \(362\)](#)
- [Light Siam \(227\)](#)
- [Siam \(208\)](#)
- [Vermilion \(39\)](#)

- [Crystal Metallic Light Gold \(001 MLG\)](#)
- [Dark Moss Green \(260\)](#)
- [Erinite \(360\)](#)
- [Palace Green Opal F \(393\)](#)
- [Shining Green \(31\)](#)

**ARTICLE EXPLANATION**

**84 501** BeCharmed Pavé Ceramics

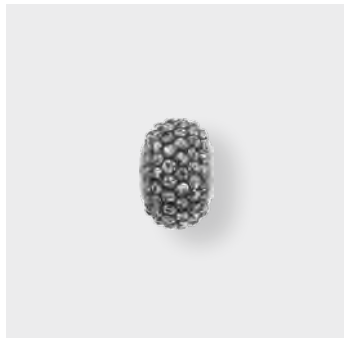

<b>S</b>	14 mm	
<b>M</b>	12 PCS	<b>100%</b>

<b>84 501</b>	<b>S</b>	<b>M</b>	<b>100%</b>
Article number	Size	Minimum Order Quantity in pieces (PCS)	Documentation size in %

**EXPLANATION OF "COLOR COMBINATIONS"**

All mentioned color combinations are pre-established in terms of

- Color of crystal
- Color of Ceralun™

and are not modifiable.

For ordering BeCharmed Pavé please follow the ordering example systematic below.

**ORDERING EXAMPLE & PRODUCT VARIETY EXPLANATION**

<b>1</b>	<b>84 501</b>	<b>36</b>	<b>653</b>
Metal Core	Article number	Color of Ceralun™	Color of crystals
1 Stainless Steel		Please see the respective product matrix for all available code references	Please see the respective product matrix for all available code references.

84 501 BeCharmed Pavé Ceramics <sup>NEW!</sup>

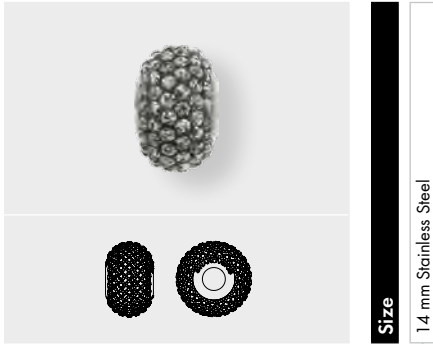

**Colors**

- Marbled Black (653)
- Shining Black (36)
- Marbled Blue (654)
- Sapphire (33)
- Marbled Light Grey (657)
- Silver (03)
- Marbled Terracotta (655)
- Antique Gold (35)
- Marbled Yellow (652)
- Olive (34)

**AVAILABLE COLORS**



Marbled Black  
(653)



Marbled Blue  
(654)

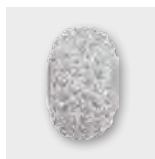

Marbled Light Grey  
(657)



Marbled Terracotta  
(655)



Marbled Yellow  
(652)

**85 001 PAVÉ THREAD RING**

The delicate and sparkling Pavé Ring is set to become the new darling among DIY jewelry enthusiasts. Designed as a connection piece, it enriches every individual design with its charm-like character.

**ARTICLE EXPLANATION**

**85 001 Pavé Thread Ring**



<b>S</b>	16.5 mm	
<b>M</b>	6 PCS	<b>100%</b>

<b>85 001</b>	<b>S</b>	<b>M</b>	<b>100%</b>
Article number	Size	Minimum Order Quantity in pieces (PCS)	Documentation size in %

**EXPLANATION OF "COLOR COMBINATIONS"**

All mentioned color combinations are pre-established in terms of

- Color of crystal
  - Color of Ceralun™
- and are not modifiable.

**ORDERING EXAMPLE & PRODUCT VARIETY EXPLANATION**

<b>1</b>	<b>85 001</b>	<b>14.5 mm</b>	<b>01</b>	<b>001</b>	<b>1</b>
Metal Core	Article number	Inner Diameter	Color of Ceralun™	Color of crystals	Hole configuration
1 Stainless Steel		14.5 mm 16.5 mm 18.5 mm	Please see the respective product matrix for all available code references	Please see the respective product matrix for all available code references.	1 1 Hole 2 2 Holes

NEW PAVÉ THREAD RING HOLE CONFIGURATIONS

85 001 Pavé Thread Ring



<b>Hole Configuration 1 (1 hole)</b>		
<b>S</b>	16.5 mm	
<b>M</b>	6 PCS	<b>100%</b>

85 001 Pavé Thread Ring



<b>Hole Configuration 2 (2 holes)</b>		
<b>S</b>	16.5 mm	
<b>M</b>	6 PCS	<b>100%</b>

85 001 Pavé Thread Ring <sup>NEW!</sup>

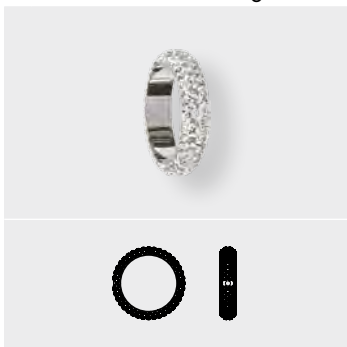

<b>Size</b>	14.5 mm Stainless Steel	16.5 mm Stainless Steel	18.5 mm Stainless Steel
-------------	-------------------------	-------------------------	-------------------------

<b>Hole Configuration</b>		
1 (with 1 hole)	<input type="checkbox"/>	<input type="checkbox"/>
2 (with 2 holes)	<input type="checkbox"/>	<input type="checkbox"/>
<b>Crystal</b>		
<input type="checkbox"/> Crystal (001)	<input type="checkbox"/>	<input type="checkbox"/>
<input type="checkbox"/> White (01)	<input type="checkbox"/>	<input type="checkbox"/>
<b>Colors</b>		
<b>Plain Colors</b>		
<input type="checkbox"/> Amethyst (204)	<input type="checkbox"/>	<input type="checkbox"/>
<input type="checkbox"/> Dark Lila (09)	<input type="checkbox"/>	<input type="checkbox"/>
<input type="checkbox"/> Aquamarine (202)	<input type="checkbox"/>	<input type="checkbox"/>
<input type="checkbox"/> Light Blue (11)	<input type="checkbox"/>	<input type="checkbox"/>
<input type="checkbox"/> Black Diamond (215)	<input type="checkbox"/>	<input type="checkbox"/>
<input type="checkbox"/> Silver (03)	<input type="checkbox"/>	<input type="checkbox"/>
<input type="checkbox"/> Dark Moss Green (260)	<input type="checkbox"/>	<input type="checkbox"/>
<input type="checkbox"/> Shining Green (31)	<input type="checkbox"/>	<input type="checkbox"/>
<input type="checkbox"/> Emerald (205)	<input type="checkbox"/>	<input type="checkbox"/>
<input type="checkbox"/> Dark Green (13)	<input type="checkbox"/>	<input type="checkbox"/>

85 001	Size		
	14.5 mm Stainless Steel	16.5 mm Stainless Steel	18.5 mm Stainless Steel
<ul style="list-style-type: none"> <li>Indian Siam (327)</li> <li>Shining Red (07)</li> </ul>	■	■	■
<ul style="list-style-type: none"> <li>Jet (280)</li> <li>Black (02)</li> </ul>	■	■	■
<ul style="list-style-type: none"> <li>Jonquil (213)</li> <li>Gold (04)</li> </ul>	■	■	■
<ul style="list-style-type: none"> <li>Light Amethyst (212)</li> <li>Mauve (14)</li> </ul>	■	■	■
<ul style="list-style-type: none"> <li>Light Rose (223)</li> <li>Rose (06)</li> </ul>	■	■	■
<ul style="list-style-type: none"> <li>Light Sapphire (211)</li> <li>Sky Blue (18)</li> </ul>	■	■	■
<ul style="list-style-type: none"> <li>Montana (207)</li> <li>Navy Blue (17)</li> </ul>	■	■	■
<ul style="list-style-type: none"> <li>Peridot (214)</li> <li>Light Green (10)</li> </ul>	■	■	■
<ul style="list-style-type: none"> <li>Rose (209)</li> <li>Rose (06)</li> </ul>	■	■	■
<ul style="list-style-type: none"> <li>Sapphire (206)</li> <li>Dark Blue (15)</li> </ul>	■	■	■
<ul style="list-style-type: none"> <li>Siam (208)</li> <li>Dark Red (16)</li> </ul>	■	■	■
<ul style="list-style-type: none"> <li>Smoked Topaz (220)</li> <li>Umber (30)</li> </ul>	■	■	■
<ul style="list-style-type: none"> <li>Tanzanite (539)</li> <li>Purple (08)</li> </ul>	■	■	■
<ul style="list-style-type: none"> <li>Topaz (203)</li> <li>Shining Curry (12)</li> </ul>	■	■	■
<b>Crystal Effects</b>			
<b>Transparent Effects</b>			
<ul style="list-style-type: none"> <li>Crystal AB (001 AB)</li> <li>White (01)</li> </ul>	■	■	■
<ul style="list-style-type: none"> <li>Crystal Golden Shadow (001 GSHA)</li> <li>Pearl Silk (05)</li> </ul>	■	■	■
<ul style="list-style-type: none"> <li>Crystal Lilac Shadow (001 LISH)</li> <li>Burgundy (29)</li> </ul>	■	■	■
<b>Color Effects</b>			
<b>Metallic Effects</b>			
<ul style="list-style-type: none"> <li>Jet Hematite (280 HEM)</li> <li>Black (02)</li> </ul>	■	■	■

# Crystal Pearls

**5810** Crystal Round Pearl

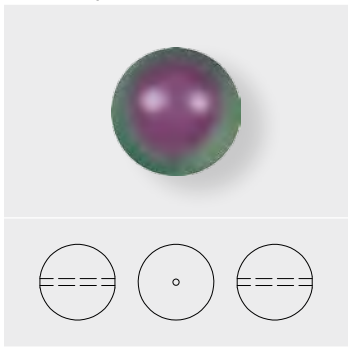

**Size**

- 3 mm
- 4 mm
- 5 mm
- 6 mm
- 8 mm
- 10 mm
- 12 mm

**Colors**

Crystal Iridescent Purple Pearl (001 943) NEW!

**5811** Crystal Pearl (large hole)

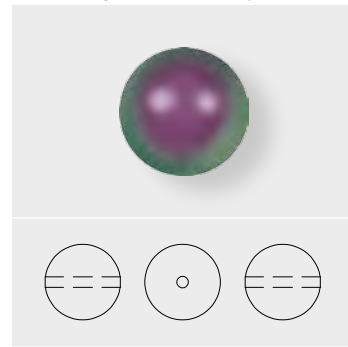

**Size**

- 10 mm
- 12 mm
- 14 mm
- 16 mm

**Colors**

Crystal Iridescent Purple Pearl (001 943) NEW!

**5817**

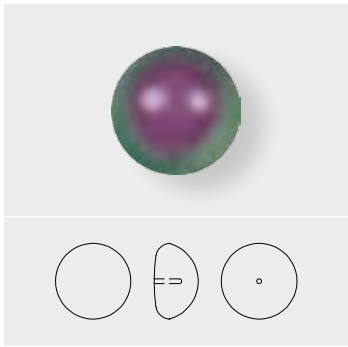

**Size**

- 6 mm
- 8 mm
- 10 mm

**Colors**

Crystal Iridescent Purple Pearl (001 943) NEW!

**5818**

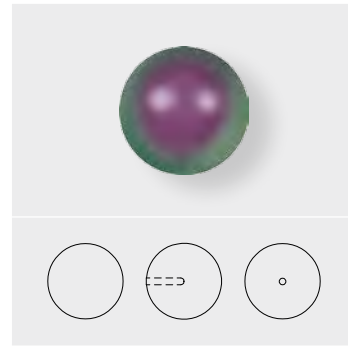

**Size**

- 4 mm
- 6 mm
- 8 mm
- 10 mm

**Colors**

Crystal Iridescent Purple Pearl (001 943) NEW!

# Crystal Pearls

## 5821 Crystal Pear-shaped Pearl

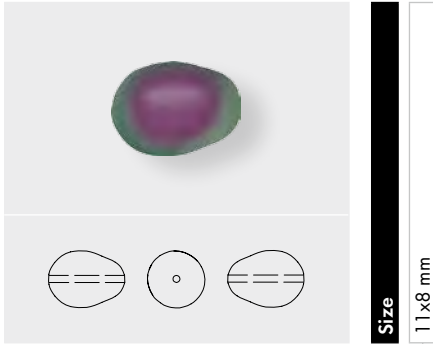

Size

11x8 mm

### Colors

 Crystal Iridescent Purple Pearl (001 943) <sup>NEW!</sup>

## 5840 Crystal Baroque Pearl

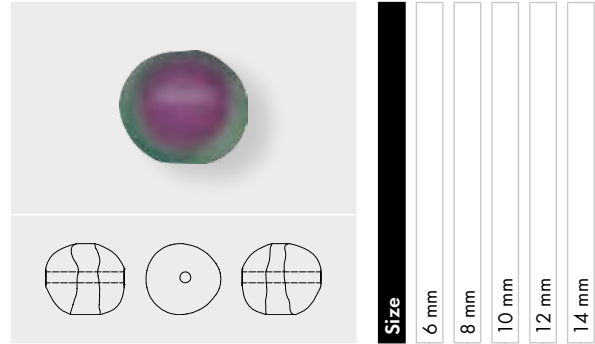

Size

6 mm

8 mm

10 mm

12 mm

14 mm

### Colors

 Crystal Iridescent Purple Pearl (001 943) <sup>NEW!</sup>

## 5860 Crystal Coin Pearl

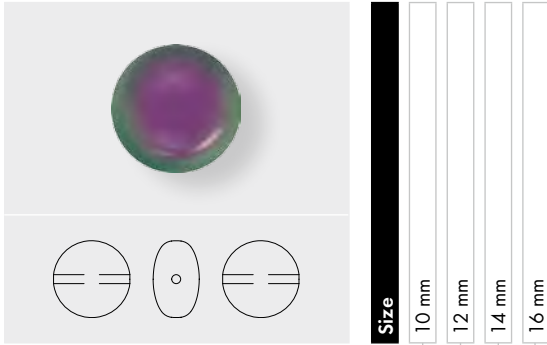

Size

10 mm

12 mm

14 mm

16 mm

### Colors

 Crystal Iridescent Purple Pearl (001 943) <sup>NEW!</sup>



# Pendants

## 6000



Size

11x5.5 mm

13x6.5 mm

15x7.5 mm

### Crystal Effects

### Transparent Effects

 Crystal Paradise Shine (001 PARSH)

NEW!

## 6010 Briolette Pendant

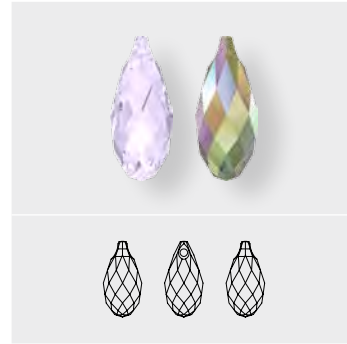

Size

11x5.5 mm

13x6.5 mm

### Colors

### Plain Colors

 Smoky Mauve (265)

NEW!

### Crystal Effects

### Transparent Effects

 Crystal Paradise Shine (001 PARSH)

NEW!

## 6040 Helios Pendant

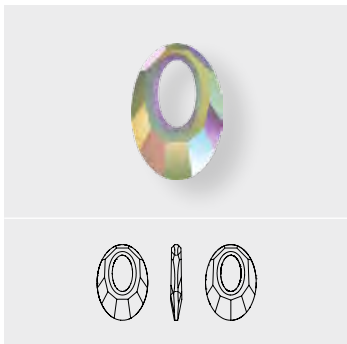

Size

20 mm

30 mm

40 mm

### Crystal Effects

### Transparent Effects

 Crystal Paradise Shine (001 PARSH)

NEW!

## 6041 Victory Pendant

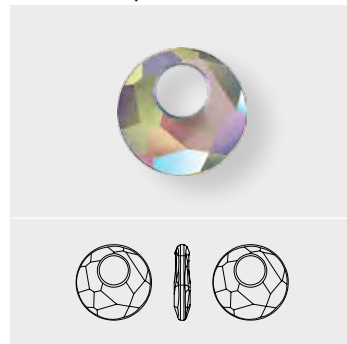

Size

18 mm

28 mm

38 mm

### Crystal Effects

### Transparent Effects

 Crystal Paradise Shine (001 PARSH)

NEW!

# Pendants

**6090 Baroque Pendant**

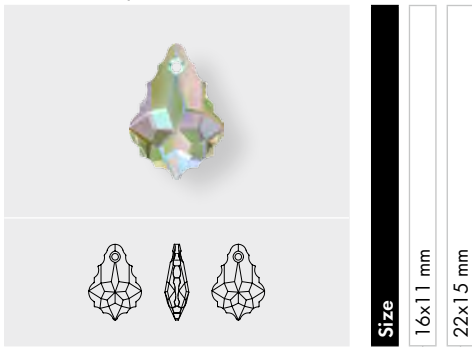

**Crystal Effects**

**Transparent Effects**

 Crystal Paradise Shine (001 PARSH) NEW!

<b>Size</b>	16x11 mm	22x15 mm
-------------	----------	----------

**6106 Pear-shaped Pendant**

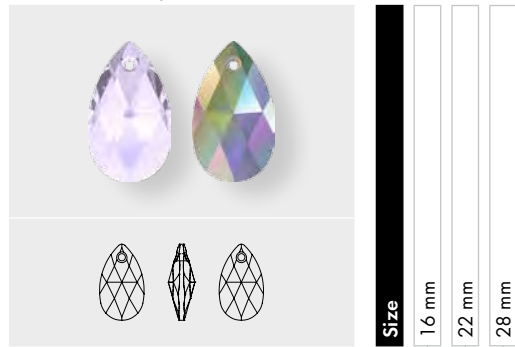

**Colors**

**Plain Colors**

 Smoky Mauve (265) NEW!

**Crystal Effects**

**Transparent Effects**

 Crystal Paradise Shine (001 PARSH) NEW!

<b>Size</b>	16 mm	22 mm	28 mm
-------------	-------	-------	-------

**6128 XILION Mini Pear Pendant**

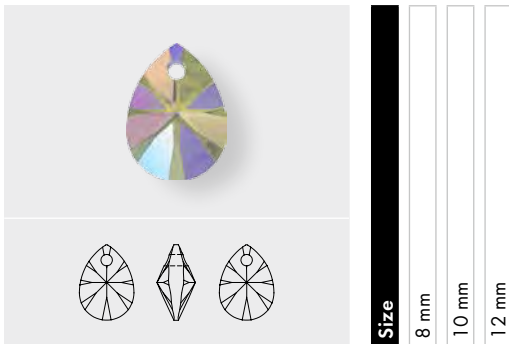

**Crystal Effects**

**Transparent Effects**

 Crystal Paradise Shine (001 PARSH) NEW!

<b>Size</b>	8 mm	10 mm	12 mm
-------------	------	-------	-------

**6228 XILION Heart Pendant**

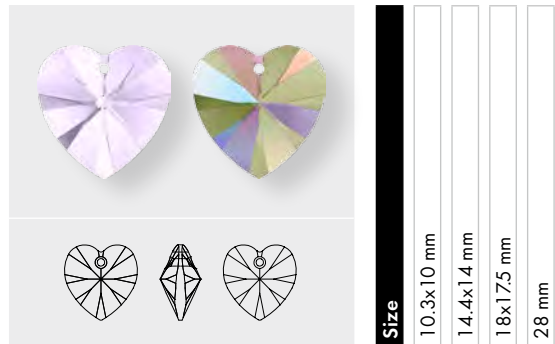

**Colors**

**Plain Colors**

 Smoky Mauve (265) NEW!

**Crystal Effects**

**Transparent Effects**

 Crystal Paradise Shine (001 PARSH) NEW!

<b>Size</b>	10.3x10 mm	14.4x14 mm	18x17.5 mm	28 mm
-------------	------------	------------	------------	-------

# Pendants

## 6328 XILION Bi-Cone Pendant

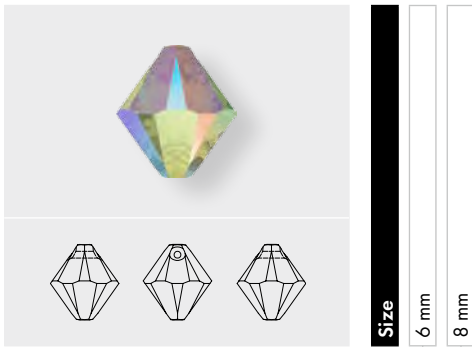

**Size**  
6 mm  
8 mm

### Crystal Effects

### Transparent Effects

Crystal Paradise Shine (001 PARSH) NEW!

## 6428 XILION Pendant

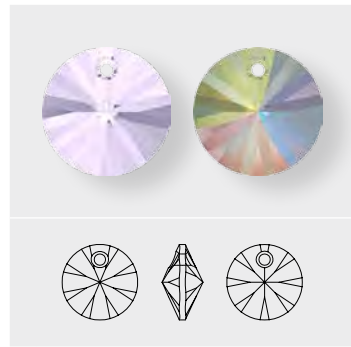

**Size**  
6 mm  
8 mm  
12 mm

### Colors

### Plain Colors

Smoky Mauve (265) NEW!

### Crystal Effects

### Transparent Effects

Crystal Paradise Shine (001 PARSH) NEW!

## 6465 Queen Baguette Pendant NEW!

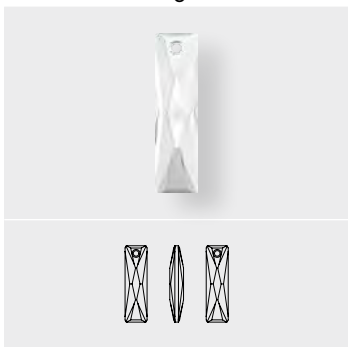

**Size**  
13.5x6 mm  
25x7 mm  
38x10 mm

### Crystal

Crystal (001)

Crystal CAL V P (001 CAL V)\*

### Colors

### Plain Colors

Aquamarine (202)

Jet (280)

Light Amethyst (212)

Montana (207)

Peridot (214)

### Crystal Effects

### Transparent Effects

Crystal AB (001 AB)

Crystal Bermuda Blue P (001 BBL)\*

Crystal Golden Shadow (001 GSHA)

Crystal Lilac Shadow (001 LISH)

Crystal Luminous Green (001 LUMG)

Crystal Paradise Shine (001 PARSH) NEW!

Crystal Red Magma (001 REDM)

Crystal Silver Night (001 SINI)

Crystal Vitrail Light P (001 VL)\*

Crystal Volcano P (001 VOL)\*

## 6628 XILION Triangle Pendant

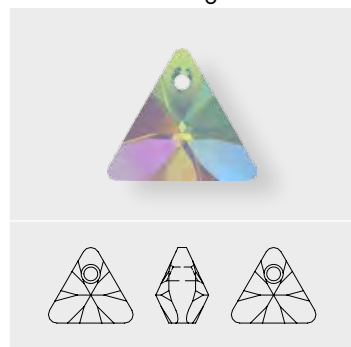

**Size**  
8 mm  
12 mm  
16 mm

### Crystal Effects

### Transparent Effects

Crystal Paradise Shine (001 PARSH) NEW!

\* For details about the "protective layer" please refer to page the chapter 'Basic Information' in the Swarovski Crystal Collection 2014.

# Pendants

## 6724 Sun Pendant <sup>NEW!</sup>

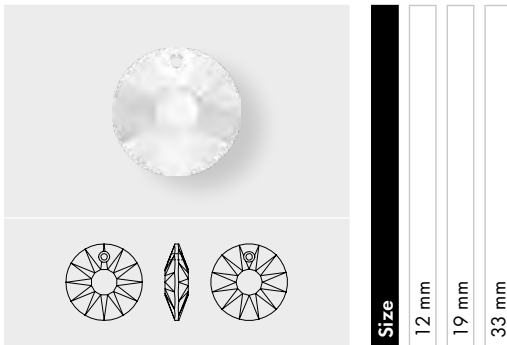

Crystal		12 mm	19 mm	33 mm
Crystal (001)		■	■	■
Crystal Effects				
Transparent Effects				
Crystal AB (001 AB)		■	■	■
Crystal Bermuda Blue P (001 BBL)*		■	■	■
Crystal Golden Shadow (001 GSHA)		■	■	■
Crystal Heliotrope P (001 HEL)*		■	■	■
Crystal Paradise Shine (001 PARSH) <sup>NEW!</sup>		■	■	■
Crystal Sahara P (001 SAH)*		■	■	■
Crystal Silver Night (001 SINI)		■	■	■
Crystal Vitrail Light P (001 VL)*		■	■	■
Crystal Vitrail Medium P (001 VM)*		■	■	■
Crystal Volcano P (001 VOL)*		■	■	■

## 6724/G Sun Pendant partly frosted <sup>NEW!</sup>

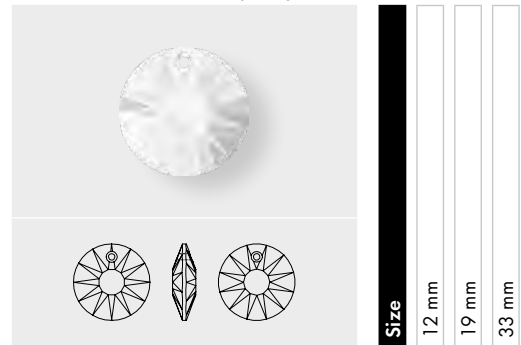

Crystal		12 mm	19 mm	33 mm
Crystal (001)		□	□	□
Crystal Effects				
Transparent Effects				
Crystal AB V (001 AB)		□	□	□
Crystal Bermuda Blue P (001 BBL)*		□	□	□
Crystal Golden Shadow V (001 GSHA)		□	□	□
Crystal Heliotrope P (001 HEL)*		□	□	□
Crystal Paradise Shine (001 PARSH) <sup>NEW!</sup>		□	□	□
Crystal Sahara P (001 SAH)*		□	□	□
Crystal Silver Night (001 SINI)		□	□	□
Crystal Vitrail Light P (001 VL)*		□	□	□
Crystal Vitrail Medium P (001 VM)*		□	□	□
Crystal Volcano P (001 VOL)*		□	□	□

## 6764 Clover Pendant

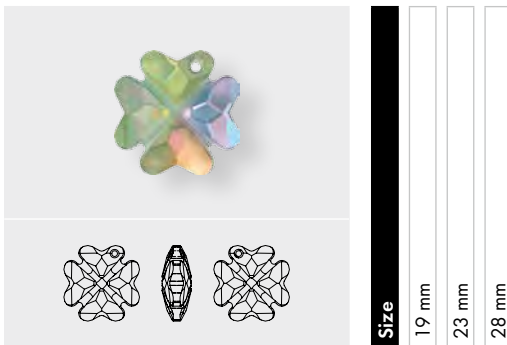

Crystal Effects		19 mm	23 mm	28 mm
Transparent Effects				
Crystal Paradise Shine (001 PARSH) <sup>NEW!</sup>		■	■	■

\* For details about the "protective layer" please refer to the chapter 'Basic Information' in the Swarovski Crystal Collection 2014.

□\* stands for "Extended Assortment". Please refer to page 15.



SWAROVSKI

COLLECTION

TAKE THOUSANDS OF CRYSTALS WHEREVER YOU GO

## Inspiration is only an App away

Wherever you are, whatever you're looking for, search over 15,000 loose elements and 200,000 forward-integrated elements with Swarovski's inspirational new Crystal Collection App. Online or offline, stay app-to-date with the latest innovations and find popular classics - it's easy to install, easy to browse, easy to use.

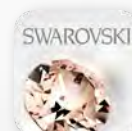

[SWAROVSKI.COM/COLLECTIONAPP](http://SWAROVSKI.COM/COLLECTIONAPP)



One step closer to the diamond

# The XIRIUS Flat Back



# Flat Backs No Hotfix

## 2058 XILION Rose Enhanced



Size	SS 5	SS 7	SS 9
<b>Colors</b>			
<b>Plain Colors</b>			
Smoky Mauve F (265)	NEW!		
<b>Crystal Effects</b>			
<b>Transparent Effects</b>			
Crystal Paradise Shine F (001 PARSH)	NEW!		

## 2088 XIRIUS Rose

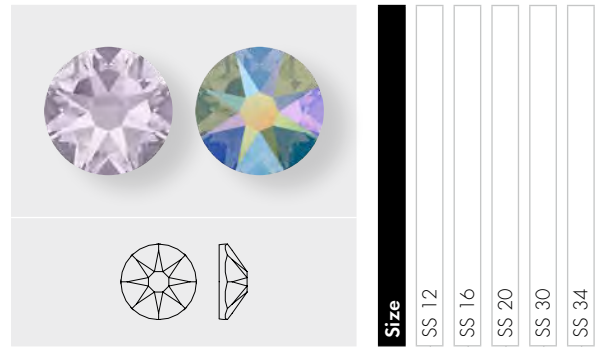

Size	SS 12	SS 16	SS 20	SS 30	SS 34
<b>Colors</b>					
<b>Plain Colors</b>					
Smoky Mauve F (265)	NEW!				
<b>Crystal Effects</b>					
<b>Transparent Effects</b>					
Crystal Paradise Shine F (001 PARSH)	NEW!				

## 2494 Starlet Flat Back <sup>NEW!</sup>



Size	6 mm	8 mm	10.5 mm
<b>Crystal</b>			
Crystal F (001)			
<b>Colors</b>			
<b>Plain Colors</b>			
Jet (280)			
Light Siam F (227)			
Light Turquoise F (263)			
Smoky Mauve F (265)	NEW!		
<b>Crystal Effects</b>			
<b>Transparent Effects</b>			
Crystal AB F (001 AB)			
Crystal Bermuda Blue F (001 BBL)			
Crystal Golden Shadow F (001 GSHA)			
Crystal Luminous Green F (001 LUMG)			
Crystal Paradise Shine F (001 PARSH)	NEW!		
Crystal Silver Night F (001 SINI)			

## 2540 Curvy Flat Back <sup>NEW!</sup>



Size	7x5.5 mm	9x7 mm	12x9.5 mm
<b>Crystal</b>			
Crystal F (001)			
<b>Colors</b>			
<b>Plain Colors</b>			
Jet (280)			
Light Siam F (227)			
Light Turquoise F (263)			
Smoky Mauve F (265)	NEW!		
Rose Peach F (262)			
<b>Crystal Effects</b>			
<b>Transparent Effects</b>			
Crystal AB F (001 AB)			
Crystal Bermuda Blue F (001 BBL)			
Crystal Golden Shadow F (001 GSHA)			
Crystal Luminous Green F (001 LUMG)			
Crystal Paradise Shine F (001 PARSH)	NEW!		
Crystal Silver Night F (001 SINI)			



# Flat Backs No Hotfix

## 2858 Bow Tie Flat Back



**Size**

- 6x4.5 mm
- 9x6.5 mm
- 12x8.5 mm

**Crystal Effects**

**Transparent Effects**

Crystal Paradise Shine F (001 PARSH) NEW!

# Flat Backs Hotfix

## 2038 XILION Rose Hotfix

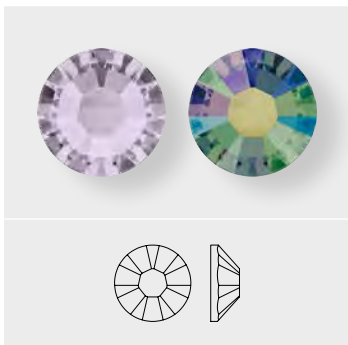

**Size**

- SS 6
- SS 8
- SS 10

**Colors**

**Plain Colors**

Smoky Mauve A HF (265) NEW!

**Crystal Effects**

**Transparent Effects**

Crystal Paradise Shine A HF (001 PARSH) NEW!

## 2078 XIRIUS Rose Hotfix

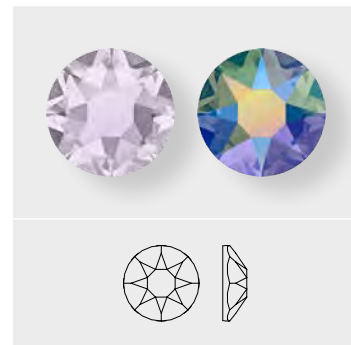

**Size**

- SS 12
- SS 16
- SS 20
- SS 34

**Colors**

**Plain Colors**

Smoky Mauve A HF (265) NEW!

**Crystal Effects**

**Transparent Effects**

Crystal Paradise Shine A HF (001 PARSH) NEW!

# Flat Backs Hotfix

## 2494 Starlet Flat Back <sup>NEW!</sup>



Crystal	6 mm	8 mm	10.5 mm
Crystal M HF (001)	■	■	■
<b>Colors</b>			
<b>Plain Colors</b>			
Jet M HF (280)	■	■	■
Light Siam M HF (227)	■	■	■
Light Turquoise M HF (263)	■	■	■
Smoky Mauve M HF (265) <sup>NEW!</sup>	■	■	■
<b>Crystal Effects</b>			
<b>Transparent Effects</b>			
Crystal AB M HF (001 AB)	■	■	■
Crystal Bermuda Blue M HF (001 BBL)	■	■	■
Crystal Golden Shadow M HF (001 GSHA)	■	■	■
Crystal Luminous Green M HF (001 LUMG)	■	■	■
Crystal Paradise Shine M HF (001 PARSH) <sup>NEW!</sup>	■	■	■
Crystal Silver Night M HF (001 SINI)	■	■	■

## 2540 Curvy Flat Back <sup>NEW!</sup>



Crystal	7x5.5 mm	9x7 mm	12x9.5 mm
Crystal M HF (001)	■	■	■
<b>Colors</b>			
<b>Plain Colors</b>			
Jet M HF (280)	■	■	■
Light Siam M HF (227)	■	■	■
Light Turquoise M HF (263)	■	■	■
Smoky Mauve M HF (265) <sup>NEW!</sup>	■	■	■
Rose Peach M HF (262)	■	■	■
<b>Crystal Effects</b>			
<b>Transparent Effects</b>			
Crystal AB M HF (001 AB)	■	■	■
Crystal Bermuda Blue M HF (001 BBL)	■	■	■
Crystal Golden Shadow M HF (001 GSHA)	■	■	■
Crystal Luminous Green M HF (001 LUMG)	■	■	■
Crystal Paradise Shine M HF (001 PARSH) <sup>NEW!</sup>	■	■	■
Crystal Silver Night M HF (001 SINI)	■	■	■

### APPLICATION ADVICE

The Starlet Flat Back Hotfix and the Curvy Flat Back Hotfix can be easily applied using a standard heat press. The use of an ultrasonic device for single-stone setting is not possible. For articles smaller than 8 mm in diameter, the application parameters for Creation Stones apply. For bigger sizes, the application parameters are the same as those that apply to Creation Stones Plus. These items are not suitable for application from the front.

### CARE INSTRUCTIONS

The care instructions for the Starlet Flat Back Hotfix and the Curvy Flat Back Hotfix are the same as those that apply to Creation Stones Plus from the Flat Back Hotfix assortment. For detailed information, please refer to the Application Manual and our business website [SWAROVSKI.COM/PROFESSIONAL](http://SWAROVSKI.COM/PROFESSIONAL).

# Flat Backs Hotfix

## 2858 Bow Tie Flat Back

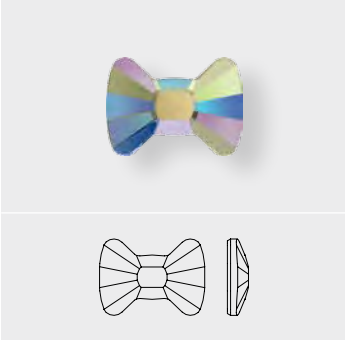

Size
6x4.5 mm
9x6.5 mm
12x8.5 mm

**Crystal Effects**

**Transparent Effects**

 Crystal Paradise Shine M HF (001 PARSH)

NEW!   

# Sew-on Articles

## 3188 XIRIUS Lochrose



Colors		Size
Plain Colors		3 mm
Smoky Mauve F (265)	NEW!	4 mm
Crystal Effects		5 mm
Transparent Effects		
Crystal Paradise Shine F (001 PARSH)	NEW!	

## 3200 Rivoli Sew-on Stone

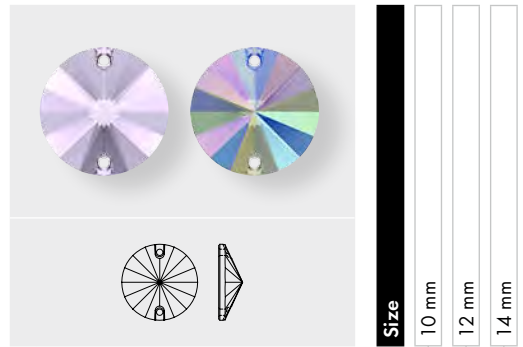

Colors		Size
Plain Colors		10 mm
Smoky Mauve F (265)	NEW!	12 mm
Crystal Effects		14 mm
Transparent Effects		
Crystal Paradise Shine F (001 PARSH)	NEW!	

## 3258 Bow Tie Sew-on Stone

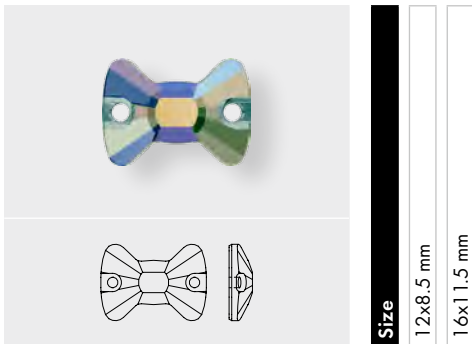

Crystal Effects		Size
Transparent Effects		12x8.5 mm
Crystal Paradise Shine F (001 PARSH)	NEW!	16x11.5 mm

# Sew-on Articles

## 3259 Heart Sew-on Stone <sup>NEW!</sup>

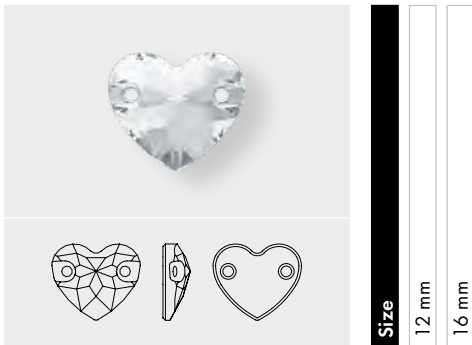

Crystal	Size	12 mm	16 mm
Crystal F (001)		■	■
<b>Colors</b>			
<b>Plain Colors</b>			
Denim Blue F (266)		■	■
Fuchsia F (502)		■	■
Jet (280)		■	■
Light Siam F (227)		■	■
Light Silk F (261)		■	■
Smoky Mauve F (265)	NEW!	■	■
Vintage Rose F (319)		■	■
<b>Opal Colors</b>			
White Opal F (234)		■	■
<b>Crystal Effects</b>			
<b>Transparent Effects</b>			
Crystal AB F (001 AB)		■	■
Crystal Golden Shadow F (001 GSHA)		■	■
Crystal Lilac Shadow F (001 LISH)		■	■
Crystal Paradise Shine F (001 PARSH)	NEW!	■	■
Crystal Silver Night (001 SINI)		■	■
<b>Metallic Effects</b>			
Crystal Rose Gold F (001 ROGL)		■	■

### APPLICATION ADVICE

Heart Sew-on Stones can be applied by hand or using a domestic or industrial sewing machine. When sewing Heart Sew-on Stones, synthetic multifilament threads with a thread count of Nm 80 are most suitable due to their abrasion resistance. Monofilament and pure cotton yarns are not recommended due to their limited abrasion resistance.

Please make sure that the transport system is deactivated to avoid any movement of the fabric. After selecting the over edge stitch, the length and width of the stitch must be adjusted to suit the element being applied. Due to the height of the article, using a program for sewing on buttons is not possible and it can only be applied without a standard presser foot.

### CARE INSTRUCTIONS

The care instructions for the Heart Sew-on Stone are the same as those that apply to the Sew-on Stone assortment. For detailed information, please refer to the Application Manual and our business website [SWAROVSKI.COM/PROFESSIONAL](http://SWAROVSKI.COM/PROFESSIONAL).

# Sew-on Articles

## 3288 XIRIUS Sew-on Stone

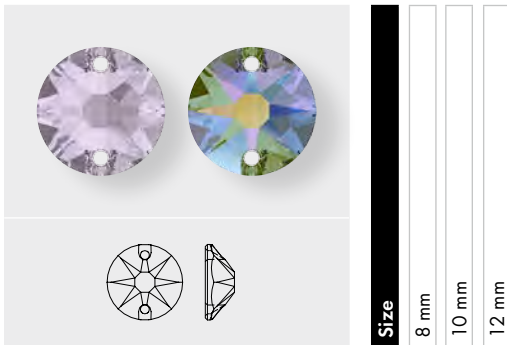

**Size**  
8 mm  
10 mm  
12 mm

### Colors

#### Plain Colors

 Smoky Mauve F (265)

NEW!

#### Crystal Effects

#### Transparent Effects

 Crystal Paradise Shine F (001 PARSH)

NEW!

# Product Details Crystal Elements

Article Size	Packing Unit = Minimum Order Quantity in Pieces	Average Net Weight in Gram per Packing Unit Crystal (001)	Average Gross Weight in Gram per Packing Unit Crystal (001)
<b>1681</b>			
12 mm	72	56.85	85.08
16 mm	48	84.67	106.93
<b>4481</b>			
12 mm	72	96.28	115.97
16 mm	48	140.23	160.06
<b>4681</b>			
14 mm	72	88.48	108.17
18 mm	48	121.28	141.14
<b>5378</b>			
14 mm	72	55.64	83.87
18 mm	48	81.73	103.06
<b>5748</b>			
12 mm	72	52.07	74.45
16 mm	48	86.16	109.47
<b>6465</b>			
13.5x6 mm	72	40.27	61.44
25x7 mm	36	51.89	75.75
38x10 mm	24	89.27	125.72
<b>6724</b>			
12 mm	144	104.44	131.74
19 mm	45	127.73	157.75
33 mm	6	79.87	105.81
<b>6724/G</b>			
12 mm	144	105.90	131.74
19 mm	45	126.25	157.75
33 mm	6	80.14	105.81
<b>2494</b>			
6 mm	220	22.30	31.45
8 mm	144	29.51	50.18
10.5 mm	96	42.74	63.82
<b>2494 HF</b>			
6 mm	220	22.30	31.45
8 mm	144	29.51	50.18
10.5 mm	96	42.74	63.82
<b>2540</b>			
7x5.5 mm	240	39.70	43.60
9x7 mm	144	37.50	59.62
12x9.5 mm	96	66.69	78.25
<b>2540 HF</b>			
7x5.5 mm	240	39.70	43.60
9x7 mm	144	37.50	59.62
12x9.5 mm	96	66.69	78.25
<b>3259</b>			
12 mm	72	53.89	77.74
16 mm	30	52.16	77.62

# Transfers

**New Exclusive Colors for art. 2038 XILION Rose and art. 2078 XIRIUS Rose**

Crystal Paradise Shine A HF (001 PARSH)  
Smoky Mauve A HF (265)

**New Exclusive Colors for Diamonds**

Crystal Paradise Shine A HF (001 PARSH)  
Smoky Mauve A HF (265)

**Available in the following sizes:**

**2038 XILION Rose**  
SS 6, SS 8, SS 10

**2078 XIRIUS Rose**  
SS 12, SS 16, SS 20, SS 34

**1360 (with art. 1028 XILION Chaton)**

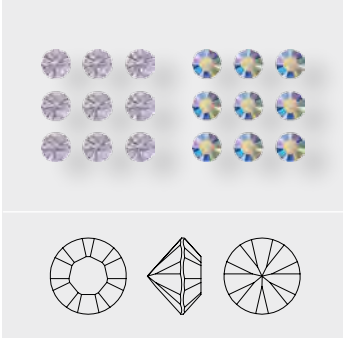

**1360 (with art. 1088 XIRIUS Chaton)**

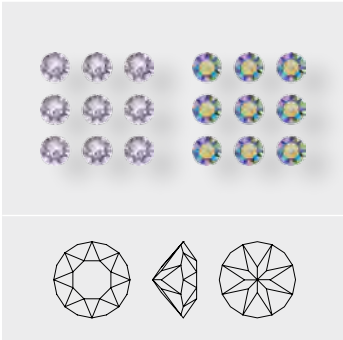

1360

Size

PP 7 (PP7 with art. 1028 XILION Chaton)

PP 12 (PP12 with art. 1028 XILION Chaton)

PP 17 (PP17 with art. 1088 XIRIUS Chaton)

Colors

Plain Colors

Smoky Mauve F (265)

NEW!

Crystal Effects

Transparent Effects

Crystal Paradise Shine F (001 PARSH)

NEW!



# Transfers

## 2494 Starlet Flat Back <sup>NEW!</sup>



**Size**  
6 mm  
8 mm  
10.5 mm

Crystal		
Crystal M HF (001)	■	■
Colors		
Plain Colors		
Jet M HF (280)	■	■
Light Siam M HF (227)	■	■
Light Turquoise M HF (263)	■	■
Smoky Mauve M HF (265) <sup>NEW!</sup>	■	■
Crystal Effects		
Transparent Effects		
Crystal AB M HF (001 AB)	■	■
Crystal Bermuda Blue M HF (001 BBL)	■	■
Crystal Golden Shadow M HF (001 GSHA)	■	■
Crystal Luminous Green M HF (001 LUMG)	■	■
Crystal Paradise Shine M HF (001 PARSH) <sup>NEW!</sup>	■	■
Crystal Silver Night M HF (001 SINI)	■	■

## 2540 Curvy Flat Back <sup>NEW!</sup>



**Size**  
7x5.5 mm  
9x7 mm  
12x9.5 mm

Crystal		
Crystal M HF (001)	■	■
Colors		
Plain Colors		
Jet M HF (280)	■	■
Light Siam M HF (227)	■	■
Light Turquoise M HF (263)	■	■
Smoky Mauve M HF (265) <sup>NEW!</sup>	■	■
Rose Peach M HF (262)	■	■
Crystal Effects		
Transparent Effects		
Crystal AB M HF (001 AB)	■	■
Crystal Bermuda Blue M HF (001 BBL)	■	■
Crystal Golden Shadow M HF (001 GSHA)	■	■
Crystal Luminous Green M HF (001 LUMG)	■	■
Crystal Paradise Shine M HF (001 PARSH) <sup>NEW!</sup>	■	■
Crystal Silver Night M HF (001 SINI)	■	■

## 2858 Bow Tie Flat Back

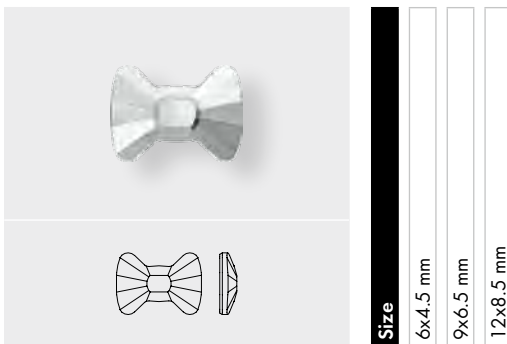

**Size**  
6x4.5 mm  
9x6.5 mm  
12x8.5 mm

Crystal Effects		
Transparent Effects		
Crystal Paradise Shine M HF (001 PARSH) <sup>NEW!</sup>	■	■



13 058

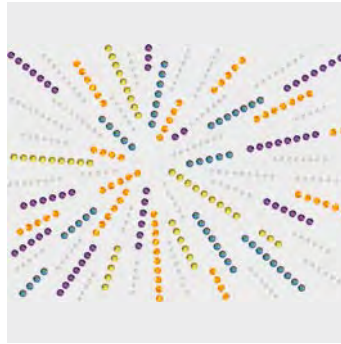

C	001AB/259/001VOL/001MBL/226
E	S3/S6/S6/S6/S6
S	~91x69
M	15 PCS
	<b>50%</b>

13 059

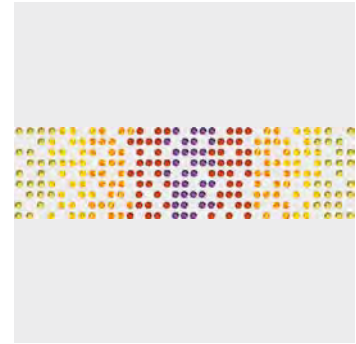

C	236/259/226/292/001VOL
E	S6/S6/S6/S6/S6
S	~91x24
M	56 PCS
	<b>50%</b>

13 060

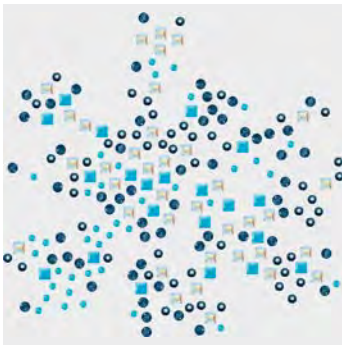

C	071/071-001AB/001METBL/266
E	M2/M3x3-CS3x3/S8/S10
S	~90x86
M	20 PCS
	<b>50%</b>

13 061

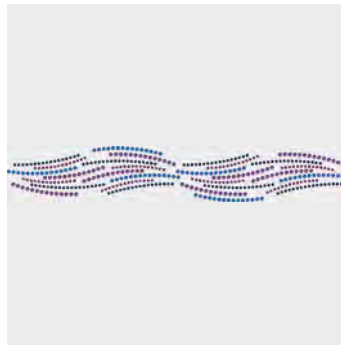

C	207/204/243/001VOL
E	S3/S3/S5/S6
S	~167x27
M	16 PCS
	<b>27%</b>

13 062

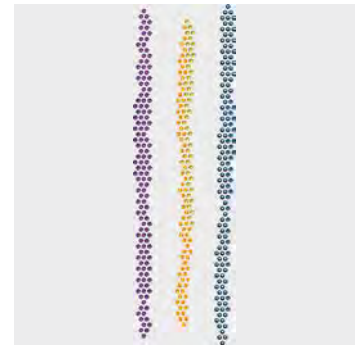

C	001METBL/001VOL/259/226/204/207
E	S6/S6/S6/S6/S6/S6
S	~44x146
M	24 PCS
	<b>31%</b>

13 063



C	243/001AB/259/226
E	S5/S5/S6/S8
S	~227x42
M	16 PCS
	<b>20%</b>

13 064

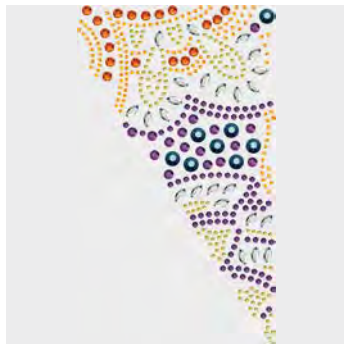

C	001AB/259/226/204/248/ 001VOL/001METBL
E	CS8x4/S6/S6/S10/S20/S20/S34
S	~96x165
M	10 PCS
	<b>27%</b>



13 049



<b>C</b>	001/001SSHA/001BLSH/266/207/280HEM
<b>E</b>	S3/S6/S6/S6/S8/S10
<b>S</b>	~85x249
<b>M</b>	4 PCS <span style="float: right;">18%</span>

13 050



<b>C</b>	001/001SSHA/266/207/001BLSH
<b>E</b>	S6/S6/S6/S6/S6
<b>S</b>	~114x124
<b>M</b>	14 PCS <span style="float: right;">35%</span>

13 051



<b>C</b>	001AB/001/001MOL
<b>E</b>	S3/S5/S6
<b>S</b>	~79x101
<b>M</b>	12 PCS <span style="float: right;">42%</span>

13 052

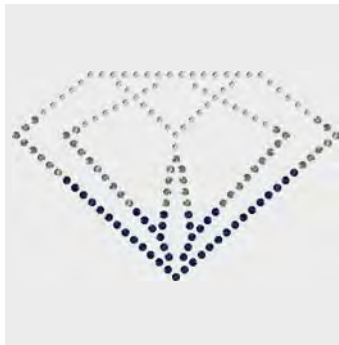

<b>C</b>	001/207/215
<b>E</b>	S3/S3/S3
<b>S</b>	~57x36
<b>M</b>	50 PCS <span style="float: right;">76%</span>

13 053



<b>C</b>	001/001/001/234
<b>E</b>	CS5x2.5/S3/S5/S6
<b>S</b>	~30x58
<b>M</b>	48 PCS <span style="float: right;">73%</span>

13 054



<b>C</b>	001/234/001MOL
<b>E</b>	CS5x2.5/S6/S8
<b>S</b>	~41x67
<b>M</b>	60 PCS <span style="float: right;">65%</span>

13 055



<b>C</b>	001/234/211/657HFT/001BLSH/001
<b>E</b>	S6/S6/S6/S8/S8/S10
<b>S</b>	~63x30
<b>M</b>	75 PCS <span style="float: right;">70%</span>

13 056



<b>C</b>	001/202/202/207/001/001/001BLSH
<b>E</b>	S3/S3/S3/S3/S5/S5/S8
<b>S</b>	~55x66
<b>M</b>	24 PCS <span style="float: right;">65%</span>

13 057



<b>C</b>	001CHRMV/001/001BLSH/234/ 001SSHA/207/657HFT	
<b>E</b>	P3/S5/S6/S6/S6/S8/S10	
<b>S</b>	~208x76	
<b>M</b>	13 PCS	21%

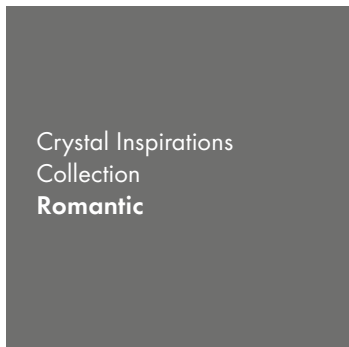

13 075



<b>C</b>	391/319/259/215	
<b>E</b>	S8/S8/S8/S8	
<b>S</b>	~185x36	
<b>M</b>	21 PCS	24%

13 076



<b>C</b>	213SAT/215/391/319/259	
<b>E</b>	S6/S6/S6/S6/S6	
<b>S</b>	~24x118	
<b>M</b>	42 PCS	37%

13 077



<b>C</b>	001SSHA/319/215/213SAT	
<b>E</b>	S6/S6/S8/S8	
<b>S</b>	~30x67	
<b>M</b>	60 PCS	66%

13 078



<b>C</b>	001SSHA/215/213SAT	
<b>E</b>	S3/S5/S6	
<b>S</b>	~137x14	
<b>M</b>	33 PCS	33%

13 079

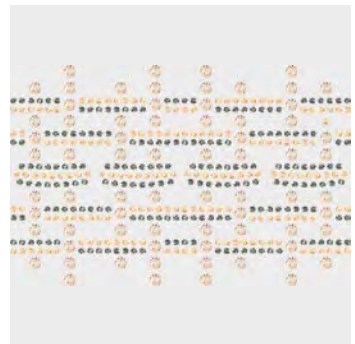

<b>C</b>	215/001GSHA/391	
<b>E</b>	S3/S3/S10	
<b>S</b>	~75x49	
<b>M</b>	18 PCS	60%

13 080

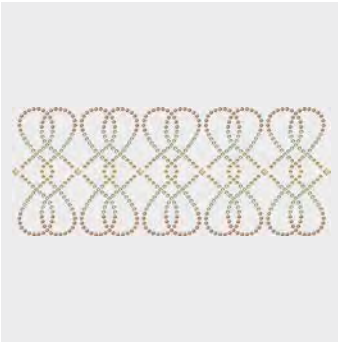

C	001GSHA/213SAT/220SAT/001GSHA
E	CS3x3/S6/S6/S6
S	~168x68
M	12 PCS
	25%

13 081



C	259/215/213SAT/220SAT
E	S6/S6/S6/S8
S	~86x90
M	20 PCS
	48%

13 082



C	223/220/259
E	S3/S3/S6
S	~482x8 (18 SEG/ROW)
M	12 ROWS
	50%

13 083



C	086-215
E	M7x3-2770MM60x35
S	~967x11 (50 SEG/ROW)
M	8 ROWS
	75%

13 067



C	070-280HEM/001/280/215/220/ 280/215/280NUT
E	M10x3-CS7x6/2797MM8x4/ 2035MM6/S3/S3/S3/S3/S6
S	~75x117
M	12 PCS
	36%

13 068



C	001SSHA/204/001LUSH/220SAT/265/ 280NUT/220/515
E	CS8x4/S3/S6/S6/S6/S8/S8/S10
S	~91x99
M	10 PCS
	44%



13 069



C	001SSHA/655HFT/280NUT/001LISH	
E	S6/S8/S8/S10	
S	~146x217	
M	6 PCS	20%

13 070



C	280HEM/280HEM/265/655HFT/001LISH	
E	CS8x5/CS5x2.5/S8/S10/S12	
S	~124x68	
M	18 PCS	36%

13 071



C	204/001LISH/220/515/280NUT	
E	S3/S6/S6/S8/S10	
S	~120x79	
M	12 PCS	36%

13 072



C	001SSHA/280HEM/265	
E	CS8x4/CS7x6/S16	
S	~32x59	
M	65 PCS	70%

13 073



C	280HEM/220/280NUT/220	
E	CS5x2.5/S6/S10/S16	
S	~101x81	
M	22 PCS	43%

13 074

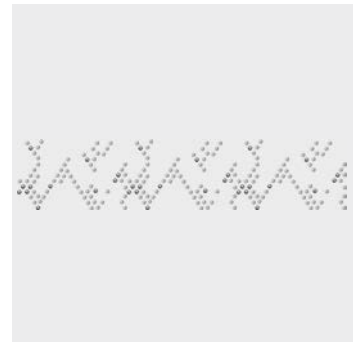

C	096-280HEM	
E	M2-S6	
S	~964x31 (20 SEG/ROW)	
M	5 ROWS	30%

ARTICLE EXPLANATION

57 000



<b>W</b> 001, 002, 003, 005, 010, 015	
<b>M</b> 10 M*	<b>100%</b>

57 306



<b>C</b> 010-001 CHRМ	
<b>S</b> ~79x76	
<b>M</b> 44 PCS	<b>40%</b>

ORDERING EXAMPLE & PRODUCT VARIETY EXPLANATION

57 306

Article number

010

Color of film

001 ANTP

Color of crystals

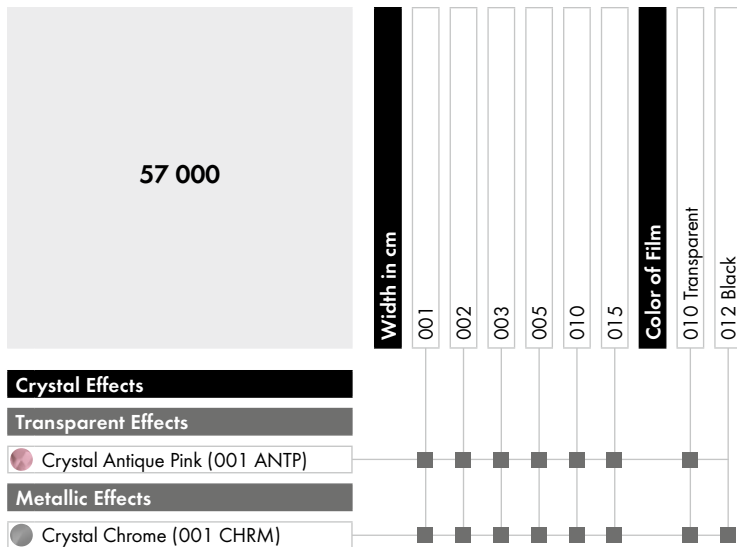

NEW EFFECTS

Crystal Antique Pink (001 ANTP)



010 Transparent

Crystal Chrome (001 CHRМ)



010 Transparent

012 Black

NEW COLORS & EFFECTS CRYSTAL ROCKS

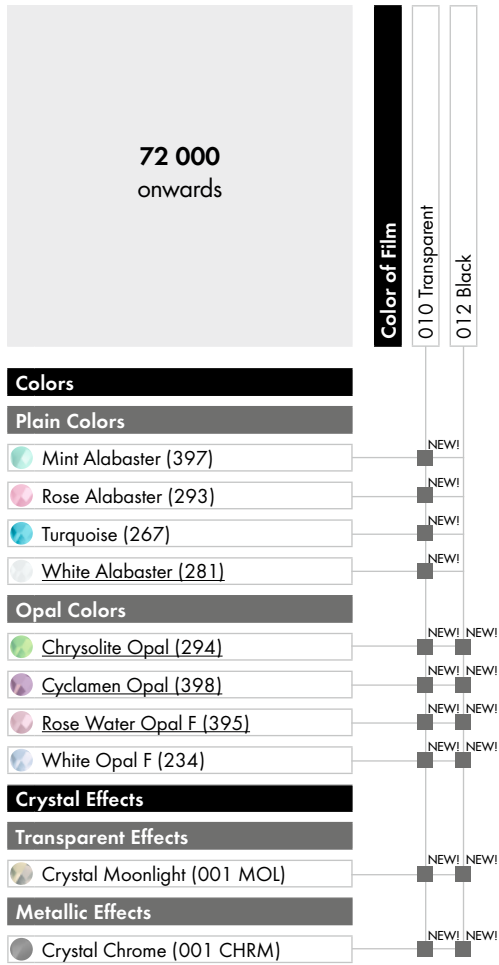

OVERVIEW OF AVAILABLE COLORS & EFFECTS

Mint Alabaster (397)



010 Transparent

Rose Alabaster (293)



010 Transparent

Turquoise (267)



010 Transparent



# Synthetics Hotfix

# Crystal Rocks

White Alabaster (281)



010 Transparent

Chrysolite Opal (294)

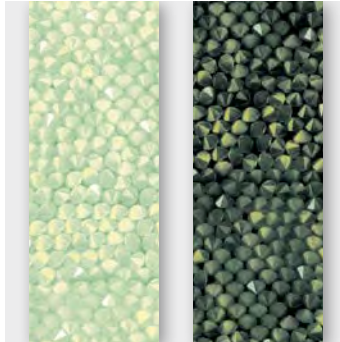

010 Transparent

012 Black

Cyclamen Opal (398)



010 Transparent

012 Black

Rose Water Opal F (395)

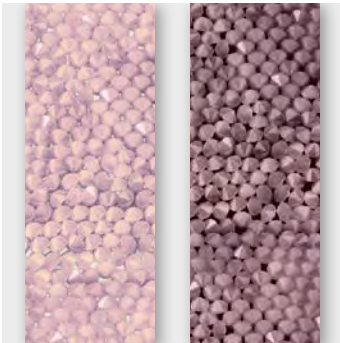

010 Transparent

012 Black

White Opal F (234)

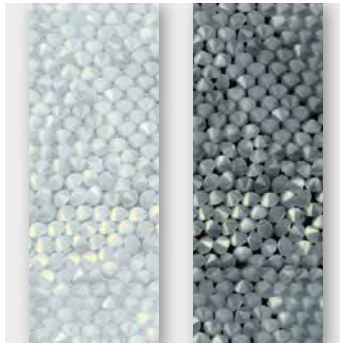

010 Transparent

012 Black

Crystal Moonlight (001 MOL)



010 Transparent

012 Black

Crystal Chrom (001 CHRM)

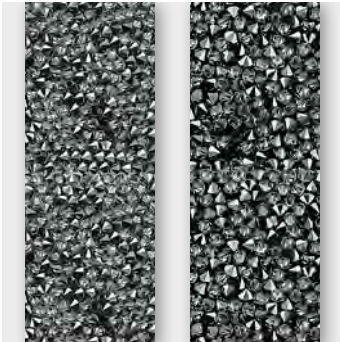

010 Transparent

012 Black

NEW COLORS & EFFECTS CRYSTAL FINE ROCKS

**74 000**  
onwards

Color of Film

010 Transparent

012 Black

**Colors**

**Plain Colors**

- Mint Alabaster (397) NEW!
- Rose Alabaster (293) NEW!
- Turquoise (267) NEW!
- White Alabaster (281) NEW!

**Opal Colors**

- Chrysolite Opal (294) NEW! NEW!
- Cyclamen Opal (398) NEW! NEW!
- Rose Water Opal F (395) NEW! NEW!
- White Opal F (234) NEW! NEW!

**Crystal Effects**

**Transparent Effects**

- Crystal Moonlight (001 MOL) NEW! NEW!

**Metallic Effects**

- Crystal Chrome (001 CHRM) NEW! NEW!

OVERVIEW OF AVAILABLE COLORS & EFFECTS

Mint Alabaster (397)



010 Transparent

Rose Alabaster (293)



010 Transparent

Turquoise (267)



010 Transparent

# Synthetics Hotfix

# Crystal Fine Rocks

White Alabaster (281)



010 Transparent

Chrysolite Opal (294)



010 Transparent

012 Black

Cyclamen Opal (398)

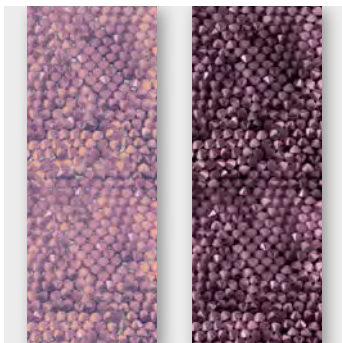

010 Transparent

012 Black

Rose Water Opal F (395)



010 Transparent

012 Black

White Opal F (234)



010 Transparent

012 Black

Crystal Moonlight (001 MOL)



010 Transparent

012 Black

Crystal Chrom (001 CHRM)

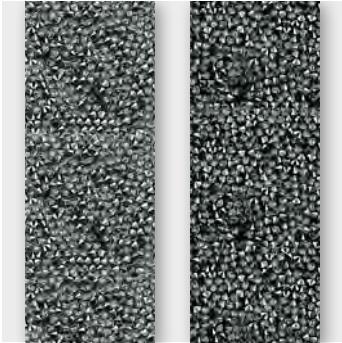

010 Transparent

012 Black

**73 000 CRYSTAL MEDLEY**

The new Crystal Medley brings together a strong carrier material with a thrilling mix of different elements, including PP 14 and PP 29 double-pointed Chatons.

**ARTICLE EXPLANATION**

**73 000**



<b>C</b>	012-001DOR
<b>S</b>	~125x81
<b>M</b>	9 PCS <b>33%</b>

<b>73 000</b>	<b>S</b>	<b>M</b>	<b>40%</b>
Article number	Size	Minimum Order Quantity in pieces (PCS)	Documentation size in %

**ORDERING EXAMPLE & PRODUCT VARIETY EXPLANATION**

<b>73 000</b>	<b>010</b>	<b>001 CAL</b>	<b>001 CAL</b>	<b>001 CAL</b>
Article number	Color of film	Crystal color corresponding to the big double pointed Chatons	Crystal color corresponding to the small double pointed Chatons	Crystal color corresponding to the round uncut elements
	010 Transparent 012 Black			

Please see the respective product matrix for all available code references.

Please note: Crystal Comet Argent Light (001 CAL) is not suitable for swimwear because the effect 001 CAL has a high level of sensitivity to seawater, sweat or chlorine water.

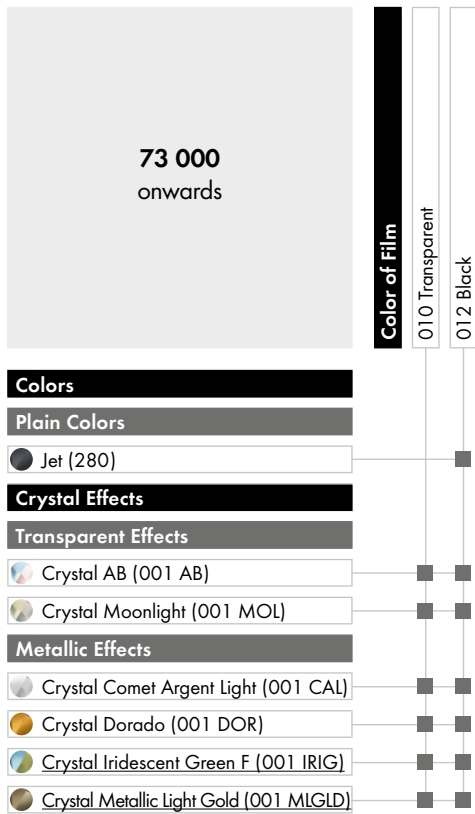

**OVERVIEW OF AVAILABLE COLORS & EFFECTS**

Jet (280)



012 Black

Crystal AB (001 AB)

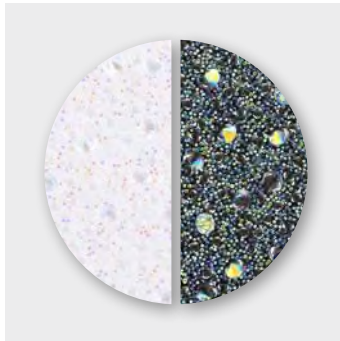

010 Transparent 012 Black

Crystal Moonlight (001 MOL)



010 Transparent 012 Black

Crystal Comet Argent Light (001 CAL)



010 Transparent 012 Black

Crystal Dorado (001 DOR)

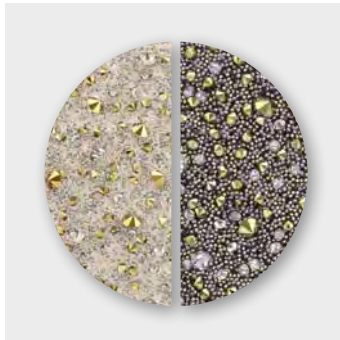

010 Transparent 012 Black

Crystal Iridescent Green F (001 IRIG)

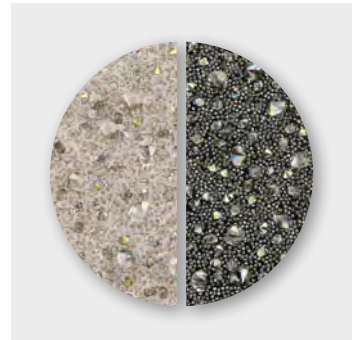

010 Transparent 012 Black

# Synthetics Hotfix

# Crystal Medley

# Motifs

Crystal Metallic Light Gold (001 MLGLD)



010 Transparent      012 Black



**73 000**



<b>C</b>	012-001DOR	
<b>S</b>	~125x81	
<b>M</b>	9 PCS	33%

**73 002**



<b>C</b>	012-001IRIG	
<b>S</b>	~37x61	
<b>M</b>	42 PCS	50%

**73 003**



<b>C</b>	010-001MOL	
<b>S</b>	~70x70	
<b>M</b>	16 PCS	22%

**73 004**



<b>C</b>	010-001MLGLD	
<b>S</b>	~124x19	
<b>M</b>	24 PCS	33%

**73 005**



<b>C</b>	012-001MOL	
<b>S</b>	~150x32	
<b>M</b>	18 PCS	28%

# Synthetics Hotfix

# Crystal Medley

# Motifs

73 007



C	010-001DOR
S	~103x53
M	15 PCS
	<b>40%</b>

73 008



C	010-001IRIG
S	~74x66
M	15 PCS
	<b>50%</b>

73 009



C	012-001IRIG
S	~67x67
M	18 PCS
	<b>22%</b>

73 010



C	012-280
S	~201x62
M	8 PCS
	<b>20%</b>

73 011



C	012-001DOR
S	~81x113
M	12 PCS
	<b>22%</b>

73 012



C	010-001CAL
S	~77x64
M	20 PCS
	<b>50%</b>

73 013



C	012-001CAL
S	~42x42
M	39 PCS
	<b>80%</b>

73 014



C	010-001MOL
S	~47x45
M	40 PCS
	<b>80%</b>

---

**SPECIAL MOTIF SERVICE**

A special motif is a design created by the customer which is different from the Crystal Medley Standard Collection. This service opens up many customization possibilities and enables you to benefit from Swarovski's longstanding experience and design expertise. A range of customization options for existing motifs is available (see "Customization Possibilities" below). You may also submit sketches of a design to suit your personal requirements – such as a brand image or an image that complements a particular sales campaign. This will then be made up according to your specifications using Computer Aided Design, which allows for easy adjustments tailored to your needs.

---

**CUSTOMIZATION POSSIBILITIES FOR CRYSTAL MEDLEY**

- Min. size: 19x19 mm or effective surface of 3.61 cm<sup>2</sup>\*
- Max. size: 400x330 mm
- Min. Crystal Medley surface: 9 mm
- Min. width of holes within motifs: 7x7 mm or effective surface of 0.49 cm<sup>2</sup>
- Min. gap between motif outlines: 6 mm

Due to production issues, motifs with edges and angles of less than 90° need to be rounded off. Tolerance value = 1.5 mm. Customers are able to create a mixture out of the Crystal Medley standard color assortment (e.g. big double pointed Chatons in 001 AB, the small double pointed Chatons in 001 AB, and the round uncut elements in 001 CAL).

---

**ORDERING PROCESS**

Send the request with a drawing you wish to order to your nearest Swarovski sales office. Make sure you include all measurements for the desired motif. Please also indicate which product group your special motif relates to (Crystal Medley).

You will then receive a quotation including your article number, minimum order quantity, price, and the line drawing of your special motif in PDF format. Please contact your Swarovski sales office again if any changes need to be made. Your special motif will be produced and delivered following your confirmation.

---

**IMPORTANT INFORMATION**

Please always submit your drawing of the desired motif in the actual size you require. When enlarged to the desired size, a small sketch will have blurred lines that will make it difficult to correctly reinterpret. Full-scale pictures or drawings representing 100% size of the design or very good quality scans in JPG, BMP, or DXF format will ensure that we have clear data to work with. These can also be sent via e-mail or on a CD-ROM. If sending a sewing pattern, please include the whole pattern and not just cut outs. If the sketch is submitted as a hard copy by fax or e-mail, please include a scale legend (e.g. copy/scan with ruler next to the drawing). This will ensure that the desired size of the motif can be identified.

Due to the tolerance level of the crystals being applied onto carrier film, the final Crystal Medley Motifs may slightly differ from the sketches or prints in relation to the motifs' outline. Therefore the product may be subject to individual variations with each reproduction. These variations are caused by technical production-related factors. As these variations are not deemed to be defects, warranty claims are excluded and Swarovski assumes no liability whatsoever in connection with them.

If detailed information on possible tolerances is needed (e.g. cavity production for a metal part) please contact Swarovski and an application request will be placed in our application database.

If considered feasible, special productions are generally offered to all our customers. Please note: special productions are subject to acceptance by Swarovski and the order of a design does not automatically grant exclusive production of this design for the customer.

For detailed application information, please refer to the Application Manual and our business website [SWAROVSKI.COM/PROFESSIONAL](http://SWAROVSKI.COM/PROFESSIONAL) or contact your Swarovski sales office.

\*min. size 17x17 mm (or effective surface of 2,89cm<sup>2</sup>) is possible for customized motifs. Please note: with this reduced minimum size, we cannot guarantee that there will be at least one PP 29 double pointed Chaton on every motif.



---

**APPLICATION ADVICE**

Crystal Medley can be easily applied using a standard heat press. The application parameters are the same as those that apply to Crystal Fabric. For detailed information, please refer to the Application Manual and our business website [SWAROVSKI.COM/PROFESSIONAL](http://SWAROVSKI.COM/PROFESSIONAL).

---

**CARE INSTRUCTIONS**

The care instructions for Crystal Medley are the same as those that apply to the Crystal Fabric assortment. For detailed information, please refer to the Application Manual and our business website [SWAROVSKI.COM/PROFESSIONAL](http://SWAROVSKI.COM/PROFESSIONAL).

**62 040 & 62 041 CRYSTALTEX CABOCHON BANDINGS**

An all-time favorite shows its soft side: the **Crystaltex Cabochon Banding** pays tribute to nature and its grandeur. Reminiscent of raindrops, the carrier material is covered either entirely with sleek Cabochons, giving an opaque look, or with a customized blend of Cabochons and crystal.

**ARTICLE EXPLANATION**

**62 040\*** NEW!

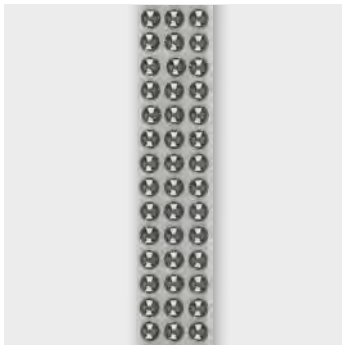

<b>R</b>	001-012, 22, 44
<b>SS</b>	SS 10 (2080/4)
<b>M</b>	5 M* <span style="float: right;"><b>100%</b></span>

**62 041\*\*** NEW!

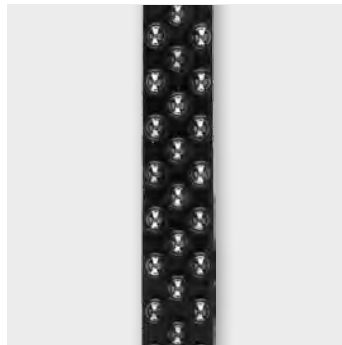

<b>R</b>	001-007, 44
<b>SS</b>	SS 10 (2080/4)
<b>M</b>	5 M* <span style="float: right;"><b>100%</b></span>

<b>62 040</b>	<b>R</b>	<b>SS</b>	<b>M</b>	<b>100%</b>
Article number	This article is available in 1 - 12, 22 and in 44 rows.	Stone Size	Minimum Order Quantity in meters (M)	Documentation size in %

**ORDERING EXAMPLE & PRODUCT VARIETY EXPLANATION**

<b>62 040</b>	<b>010</b>	<b>S010</b>	<b>001 296</b>
Article number	3-digit code for number of rows	Color of base material	Color of crystals
	This article is available in 001-012, in 022 and in 044 rows.	010 Transparent 012 Black	Please see the respective color matrix for all available code references.
<b>62 041</b>	<b>010</b>	<b>S010</b>	<b>001 296</b>
Article number	3-digit code for number of rows	Color of base material	Color of crystals
	This article is available in 001-007 and in 044 rows.	010 Transparent 012 Black	Please see the respective color matrix for all available code references.

\* article is available in 001-012, 22 and 44 rows.

\*\* article is available in 001-007 and 44 rows.

AVAILABLE BASE MATERIALS AND COLORS & EFFECTS

**62 040\***  
**62 041\*\***

Color of Film	010 Transparent	012 Black
<b>Colors</b>		
<b>Plain Colors</b>		
● Jet (280)	■	■
<b>Crystal Pearl Colors</b>		
● Crystal Creampearl (001 291)	■	■
● Crystal Dark Grey Pearl (001 617)	■	■
● Crystal Light Grey Pearl (001 616)	■	■
● Crystal Rosaline Pearl (001 294)	■	■
● Crystal White Pearl (001 650)	■	■
<b>Crystal Effects</b>		
<b>Transparent Effects</b>		
● Crystal Golden Shadow (001 GSHA)	■	■
<b>Metallic Effects</b>		
● Crystal Chrom V (001 CHRMV)	■	■
<b>Crystal Color Effects</b>		
<b>Metallic Effects</b>		
● Jet Hematite (280 HEM)	■	■

**62 040\***  
**62 041\*\***

Color of Film	010 Transparent	012 Black
<b>Multicolors</b>		
● Crystal AB & ● Crystal White Pearl (M400)	■	■
● Jet Hematite & ● Jet Hematite (M402)	■	■
● Silk & ● Crystal Creampearl (M403)	■	■
● Crystal Silver Shade & ● Crystal Light Grey Pearl (M404)	■	■
● Light Rose & ● Crystal Rosaline Pearl (M405)	■	■
● Crystal Iridescent Green & ● Crystal Light Grey Pearl (M407)	■	■
● Crystal Rose Gold & ● Crystal Creampearl (M408)	■	■

\* article is available in 001-012, 22 and 44 rows.

\*\* article is available in 001-007 and 44 rows.

OVERVIEW OF ALL AVAILABLE MULTICOLORS (ON SELECTED FILMS)\*

Crystal AB &  
Crystal White Pearl (M400)



010 Transparent

Jet Hematite &  
Jet Hematite (M402)

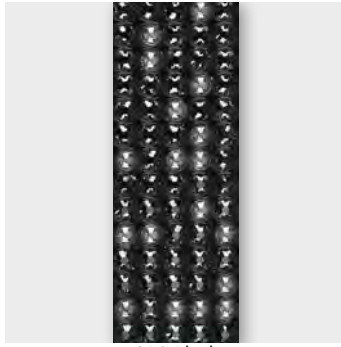

012 Black

Silk &  
Crystal Creampearl (M403)



010 Transparent

Crystal Silver Shade &  
Crystal Light Grey Pearl (M404)



010 Transparent

Light Rose &  
Crystal Rosaline Pearl (M405)

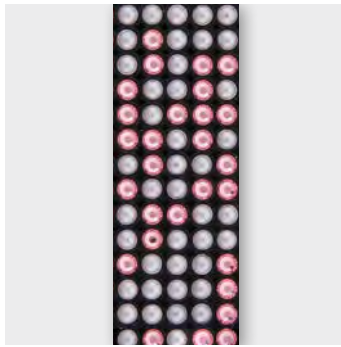

012 Black

Crystal Iridescent Green &  
Crystal Light Grey Pearl (M407)



010 Transparent

Crystal Rose Gold &  
Crystal Creampearl (M408)

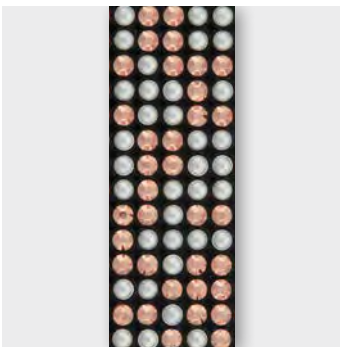

012 Black

\* please see the respective matrix for all available color and film variations

**ARTICLE EXPLANATION**

**66 045**



<b>C</b>	S010-391/001 291
<b>E</b>	SS 10/P3
<b>S</b>	~27x17
<b>M</b>	19.636 metres (720 PCS)   <b>73%</b>

<b>66 045</b>	<b>C</b>	<b>E</b>	<b>S</b>	<b>M</b>	<b>73%</b>
Article number	Color assortment	Elements	Motif size in mm	Minimum Order Quantity in meters (M); pieces (PCS)	Documentation size in %
	Color of base material (S010, S012) is separated from crystal colors with a hyphen. Color code 1 (391) corresponds to element 1; color code 2 (001 291) corresponds to element 2, etc.	Crystaltex Cabochon Bandings Motifs are available in stone size SS 10 in close stone setting			

**ORDERING EXAMPLE & PRODUCT VARIETY EXPLANATION**

<b>66 045</b>	<b>S010</b>	<b>391</b>	<b>001 291</b>
Article number	Color of base material	Crystal color corresponding to element 1; color of most frequently used element in the motif.	Crystal color corresponding to element 2; color of second most frequently used element in the motif.
	010 Transparent 012 Black	Please see the respective color matrix for all available code references.	



66 044

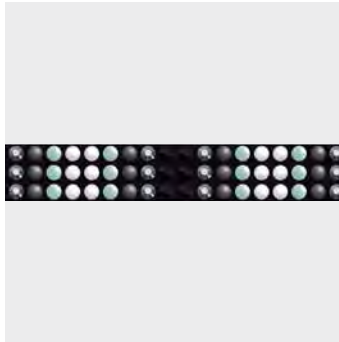

<b>C</b>	S012-280HEM/280/001650/ 001616/001617	
<b>E</b>	S10/S10/P3/P3/P3	
<b>S</b>	~477x10	
<b>M</b>	33.408 metres (70 PCS)	<b>72%</b>

66 045



<b>C</b>	S010-391/001 291	
<b>E</b>	SS 10/P3	
<b>S</b>	~27x17	
<b>M</b>	19.636 metres (720 PCS)	<b>73%</b>

66 046



<b>C</b>	S010-280HEM/220/001617	
<b>E</b>	SS10/SS10/P3	
<b>S</b>	~44x17	
<b>M</b>	19.499 metres (440 PCS)	<b>49%</b>

**APPLICATION ADVICE**

Crystaltext Cabochons can be easily applied using a standard heat press. The application parameters are the same as those that apply to Crystaltext Chatons. In order to protect the crystals' lacquer from damage it is recommended that you apply Crystaltext Cabochons from the back side. If an application from the front side is unavoidable, make sure to protect the crystals from mechanical damage (scratching) by using a pressure compensator (e.g. silicone pad). Please regard that the use of a compensating underlay will extend the application time. For detailed information, please refer to the Application Manual and our business website [SWAROVSKI.COM/PROFESSIONAL](http://SWAROVSKI.COM/PROFESSIONAL).

**CARE INSTRUCTIONS**

The care instructions for Crystaltext Cabochons are the same as those that apply to the Crystaltext assortment, although only hand wash for Crystaltext Cabochons is recommended. For detailed information, please refer to the Application Manual and our business website [SWAROVSKI.COM/PROFESSIONAL](http://SWAROVSKI.COM/PROFESSIONAL).

A standard assortment of Transfers or Synthetics (such as Crystal Fabric, Crystal Rocks, Crystal Fine Rocks, Crystaltex, or Crystaltex Chaton) is available pre-applied to Alcantara®, a fabric similar to leather – for a smooth, soft effect, lightweight quality, and myriad application options!

Bandings with Transfers and Synthetics are elegant, fashionable, and easy to handle. Both are sold by the roll, which makes customized cutting fast and easy.

**88 600 ONWARDS BANDINGS WITH CRYSTAL ROCKS**

**ARTICLE EXPLANATION**

**88 600** Banding with Crystal Rocks

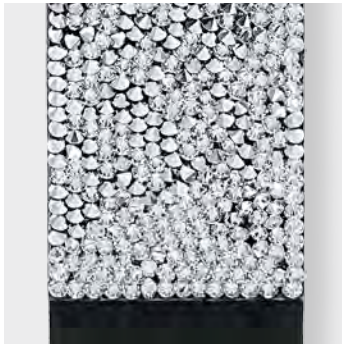

<b>W</b> 035	
<b>S</b> M	
<b>B</b> B012	
<b>C</b> 010 - 001 CAL	
<b>M</b> 22 PCS	<b>100%</b>

<b>88 600</b>	<b>W</b>	<b>S</b>	<b>B012</b>	<b>Film color</b>	<b>Color of crystals</b>	<b>M</b>	<b>100%</b>
Article number	035	M	B012	010	001 CAL	Minimum Order Quantity in pieces (PCS)	Documentation size in %

**ORDERING EXAMPLE & PRODUCT VARIETY EXPLANATION**

<b>88 600</b>	<b>035</b>	<b>S</b>	<b>B003</b>	<b>010</b>	<b>001 MLGLD</b>
Article number	3-digit code for width in mm	Size	Color of banding according to Alcantara® color matrix	Color of film	Color of crystals
	015 (15 mm)	S (151 mm)		010 Transparent	Please see the respective product matrix for all available code references.
	025 (25 mm)	M (162 mm)		012 Black	
	035 (35 mm)	L (174 mm)			

The product is delivered on a roll with 22 already applied motifs.

**AVAILABLE WIDTH**

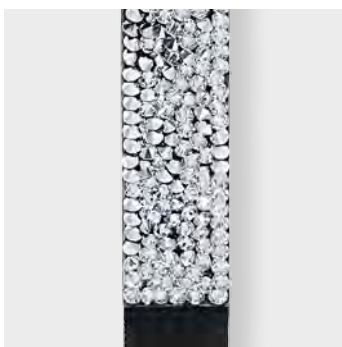

15 mm

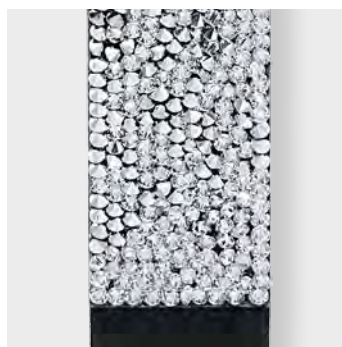



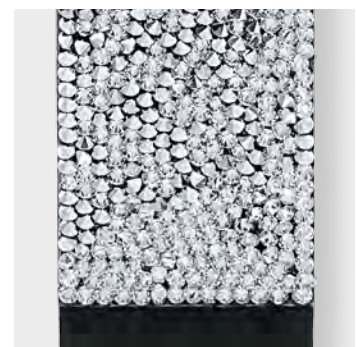





















25 mm



35 mm

**OVERVIEW OF AVAILABLE ALCANTARA® COLORS:**

Alcantara® Color	Fabric Color & Code
black (T9990T)	 B012
anthracite (T6422T)	 B001
grey (T5901D)	 B002
light grey (T4078T)	 B003
nacre (T1042T)	 B004
white (T1105T)	 B022
beige (T1110D)	 B005
light brown (T3051D)	 B006
brown (T6833D)	 B008
light blue (D2129)	 B009
blue (T4175D)	 B010
zircon (T6502D)	 B011
dark blue (D6440D)	 B024
dark indigo (T9100T)	 B013
emerald (D4129D)	 B014
moos green (T6501D)	 B015
ocher (T1125C)	 B016
red (T6357D)	 B017
dark rose (C4119D)	 B018
burgundy (T7569T)	 B019
light rose (D1043D)	 B020
rose (D1012D)	 B021
amethyst (D4148D)	 B023
fuchsia (T3912C)	 B025
purple (T6601C)	 B026

**PRODUCT DETAILS AND CUSTOMIZATION POSSIBILITIES**

The product is delivered on a roll with 22 motifs already applied. The distance between the motifs is 5 cm.

**ORDERING PROCESS**

It is possible to create customized Bandings within the defined standard width and length.

Send the request with a drawing you wish to order to your nearest Swarovski sales office. Make sure you include the measurements of the desired motif (width: 1.5 cm, 2.5 cm or 3.5 cm, length: 15.1 cm, 16.2 cm or 17.4 cm). Please also indicate which product group your special motif relates to.

**Please note that a special production request has to be placed for two-colored Crystal Fabric, Crystaltex Chaton and Crystal (Fine) Rocks special motifs.**

E.g. Art. 88 302

Other color combinations of this standard motif can be ordered normally. In case the customer requires a different two-colored motif, a special production request has to be placed.

**MINIMUM ORDER QUANTITIES**

The minimum order quantity for standard articles is one roll.

For special productions, the MOQ depends on the product and motif used for the banding.



**BANDINGS WITH... COLOR ASSORTMENT:**

For the available Colors & Effects for Bandings with... please refer to the respective color matrix of the corresponding product groups (Crystal Rocks, Crystal Fine Rocks, Crystal Fabric, Crystalstex, Crystalstex Chaton, Transfers) which can be found in the Crystal Collection 2014.



**88 600**



W	035
S	M
B	B003
C	010-001 MIGLD
M	22 PCS
	<b>25%</b>

**88 601**

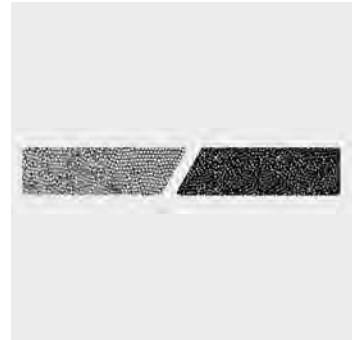

W	025
S	M
B	B012
C	010-001 CAL/012 280
M	22 PCS
	<b>25%</b>

**88 602**



W	025
S	M
B	B005
C	001 001 GSHA/012 001 REDM
M	22 PCS
	<b>25%</b>

**88 603**



W	035
S	M
B	B001
C	010 001 CAL/012 001 METSI
M	22 PCS
	<b>25%</b>



**88 901**



W	035
S	M
B	B012
C	012-280/010-001 CAL
M	22 PCS
	<b>25%</b>

**88 902**



W	025
S	M
B	B001
C	010-001 CAL/010-001 MIGLD
M	22 PCS
	<b>25%</b>

88 903



W	025	
S	M	
B	B013	
C	010-001 CAL/012-001 BBL	
M	22 PCS	25%

88 904



W	025	
S	M	
B	B021	
C	010-243	
M	22 PCS	25%

Standard Collection  
Bandings with  
Crystal Fabric  
88 300 onwards

88 301



W	035	
S	M	
B	B002	
C	001 CAL/012-001 MOL	
M	22 PCS	25%

88 302

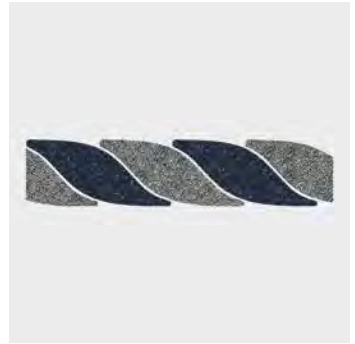

W	035	
S	M	
B	B001	
C	001 CAL/012 280 HEM	
M	22 PCS	25%

88 303



W	035	
S	M	
B	B013	
C	012 280 HEM/010-001 CAL	
M	22 PCS	25%

88 304



W	025	
S	M	
B	B012	
C	010-001 MlGLD/012-280 HEM	
M	22 PCS	25%

88 305



W	025	
S	M	
B	B002	
C	010-001 CHR M	
M	22 PCS	25%

Standard Collection  
**Bandings with  
 Crystaltex**  
 89 200 onwards

**89 200**



W	025	
S	M	
B	B012	
C	S010-223/502/204	
M	22 PCS	25%

**89 201**



W	025	
S	M	
B	B025	
C	S012-280 HEM/1001 ROGL/391	
M	22 PCS	25%

**89 202**



W	035	
S	M	
B	B012	
C	F083-001 AB/502/227	
M	22 PCS	25%

**89 203**



W	025	
S	M	
B	B012	
C	F082-001 ROGL/S012-391	
M	22 PCS	25%

**88 204**



W	035	
S	M	
B	B020	
C	S010-001 ROGL	
M	22 PCS	25%

Standard Collection  
**Bandings with  
 Crystaltex Chaton**  
 89 500 onwards

**89 500**

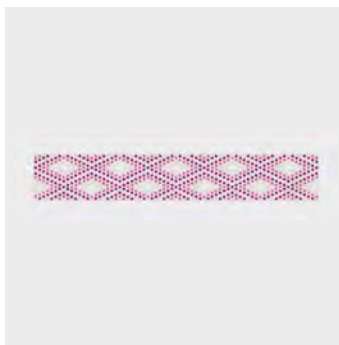

W	025	
S	M	
B	B012	
C	S010-502/209/001 AB	
M	22 PCS	25%

**89 501**

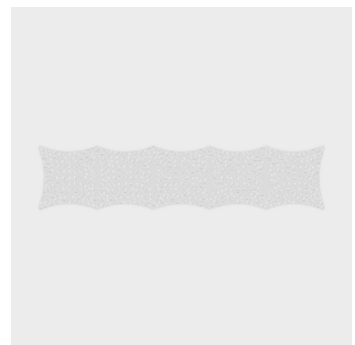

W	035	
S	M	
B	B012	
C	S010-001	
M	22 PCS	25%

89 502



W	035
S	M
B	B012
C	S010-001/502
M	22 PCS
	25%

89 503

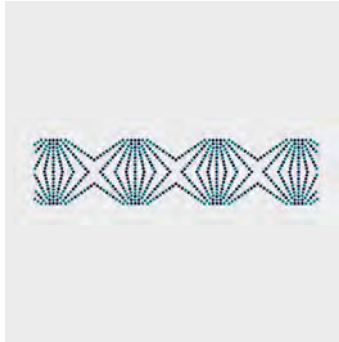

W	035
S	M
B	B012
C	S010-288/379
M	22 PCS
	25%

88 504



W	025
S	M
B	B012
C	S010-001
M	22 PCS
	25%

Standard Collection  
Bandings with  
Transfers  
88 000 onwards

88 000

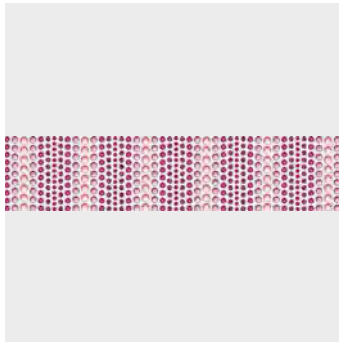

W	035
S	M
B	B025
C	501/001 LISH/502/209/223
M	22 PCS
	28%

88 001

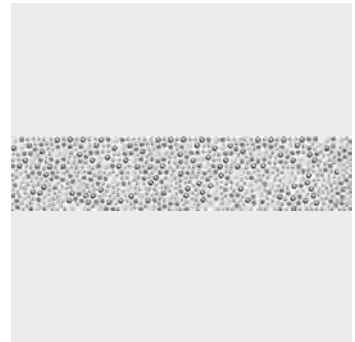

W	035
S	M
B	B012
C	096/086/012-001 SSHA/280 HEM
M	22 PCS
	28%

88 002



W	025
S	M
B	B025
C	001 650/001/280 HEM/001 SSHA/280
M	22 PCS
	28%

88 003

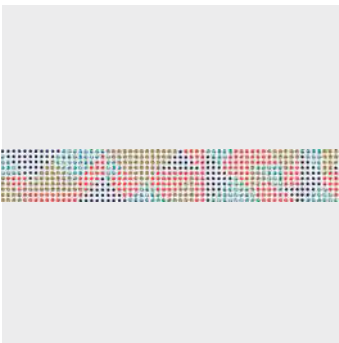

W	025
S	M
B	B013
C	207/262/001 MLGLD/001 IRIG
M	22 PCS
	28%

88 004

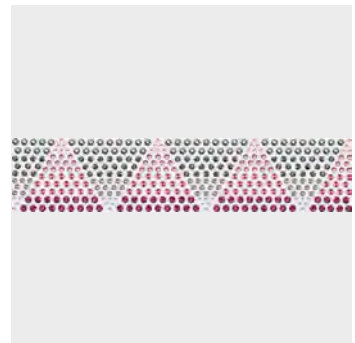

W	035
S	M
B	B012
C	223/001/215/209/289/001 SINI/001 LISH/280 HEM
M	22 PCS
	28%

88 005

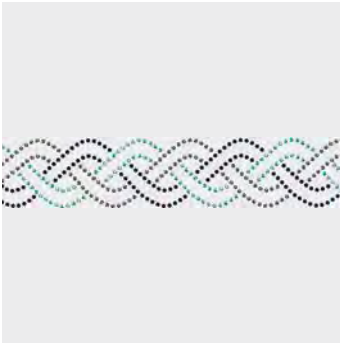

<b>W</b>	035	
<b>S</b>	M	
<b>B</b>	B001	
<b>C</b>	001 SINI/288/001 IRIG	
<b>M</b>	22 PCS	28%

88 006

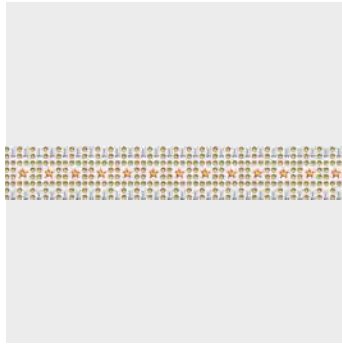

<b>W</b>	025	
<b>S</b>	M	
<b>B</b>	B006	
<b>C</b>	001/001 ROGL/001 SSHA	
<b>M</b>	22 PCS	28%

88 007

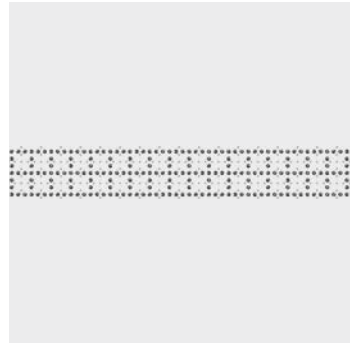

<b>W</b>	035	
<b>S</b>	M	
<b>B</b>	B001	
<b>C</b>	001/001 SINI	
<b>M</b>	22 PCS	28%

88 008

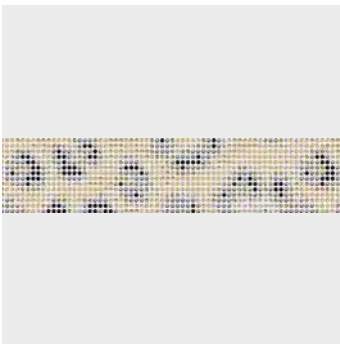

<b>W</b>	035	
<b>S</b>	M	
<b>B</b>	B008	
<b>C</b>	246/280 HEM/284/001 MLGLD/ 280/001 GHSA	
<b>M</b>	22 PCS	28%

88 009

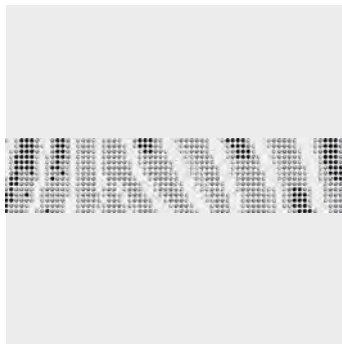

<b>W</b>	035	
<b>S</b>	M	
<b>B</b>	B012	
<b>C</b>	280 HEM/001 SSHA/001 MOL/280	
<b>M</b>	22 PCS	28%

**3011 Clover Crystal Button** <sup>NEW!</sup>

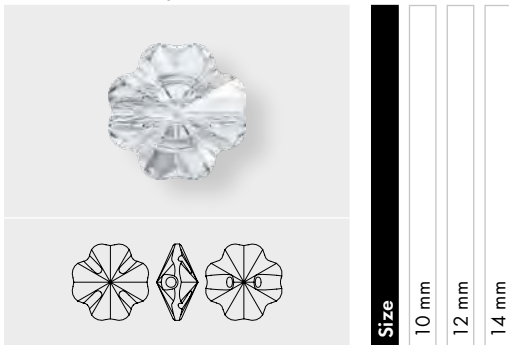

Crystal	10 mm	12 mm	14 mm
Crystal (001)	■	■	■
Crystal F (001)	■	■	■
Colors			
Plain Colors			
Emerald (205)	■	■	■
Jet (280)	■	■	■
Peridot (214)	■	■	■
Crystal Effects			
Transparent Effects			
Crystal AB (001 AB)	■	■	■
Crystal Blue Shade (001 BLSH)	■	■	■
Crystal Golden Shadow (001 GSHA)	■	■	■
Crystal Luminous Green (001 LUMG)	■	■	■
Crystal Paradise Shine (001 PARSH)	■	■	■
Crystal Silver Night (001 SINI)	■	■	■

**APPLICATION ADVICE**

The Clover Crystal Button can be applied by hand or using a domestic or industrial sewing machine. When sewing Clover Crystal Buttons, synthetic multifilament threads with a thread count of Nm 80 are most suitable due to their abrasion resistance. Monofilament and pure cotton yarns are not recommended due to their limited abrasion resistance. Please make sure that the transport system is deactivated to avoid any movement of the fabric. After selecting the over edge stitch, the length and width of the stitch must be adjusted to suit the element being applied. Due to the height of the article, using a program for sewing on buttons is not possible and it can only be applied without a standard presser foot.

**CARE INSTRUCTIONS**

The care instructions for the Clover Crystal Button are the same as those that apply to the Crystal Button assortment. For detailed information, please refer to the Application Manual and our business website [SWAROVSKI.COM/PROFESSIONAL](http://SWAROVSKI.COM/PROFESSIONAL).

**Product Details Crystal Elements**

Article Size	Packing Unit = Minimum Order Quantity in Pieces	Average Net Weight in Gram per Packing Unit Crystal (001)	Average Gross Weight in Gram per Packing Unit Crystal (001)
<b>3011</b>			
10 mm	144	65.86	85.46
12 mm	144	96.77	119.15
14 mm	72	70.76	91.66

# Rose Gold Plating

## ROSE GOLD PLATING FOR BUTTONS, FASTENERS & METAL TRIMMINGS

The following Buttons, Fasteners & Metal Trimmings will be available with Rose Gold Plating:

### Buttons & Fasteners:



**1780/100**  
11 mm

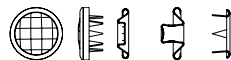

**1786/100**  
11 mm



**1790/114**  
14 mm

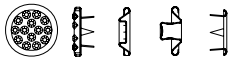

**1780/114**  
11 mm

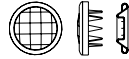

**1786/101**  
11 mm



**1790/140**  
17 mm

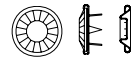

**1781/100**  
11 mm

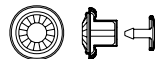

**1790/100**  
14 mm



**1796/140**  
17 mm

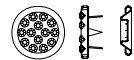

**1781/114**  
11 mm



**1790/104**  
17 mm

### Metal Trimmings:



**55 000, 55 001**  
**55 500, 55 501**  
SS 12, 20



**53 500, 53 501**  
**53 502**  
4, 6, 8 mm



**53 100, 53 102**  
**53 103**  
SS 12, 16, 30



**52 000, 52 001**  
**52 500, 52 501**  
SS 18, PP 24



**53 600**  
6 mm



**53 200, 53 203**  
**53 201**  
PP 31, PP 29

All Motifs



**53 700**  
10 mm



**53 000, 53 002,**  
**53 001, 53 005,**  
**53 006**  
SS 18, 29, 34, 39  
PP 24



**53 010, 53 011**  
SS 29, SS 39  
In co-operation with  
Jean Paul Gaultier



**53 400, 53 401,**  
**53 402**  
6, 8, 10 mm



**53 503**  
8 mm  
In co-operation with  
Jean Paul Gaultier

# Rose Gold Plating

---

## ARTICLE EXPLANATION

This is only an article explanation of one of the items which will be available with Rose Gold Plating.

### 53 006 Rivets

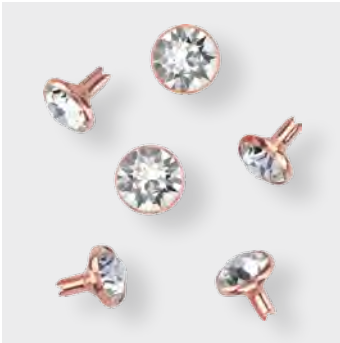

SS SS 39

M 300 PCS	100%
-----------	------

53 000	SS	M	100%
Article number	Stone size	Minimum order quantity in pieces (PCS)	Documentation size in %

---

## ORDERING EXAMPLE & PRODUCT VARIETY EXPLANATION

53 000	093	010
Article number	Color of casing	Color of crystal
	081 Gold 082 Silver 086 Gun Metal 088 Stainless Steel 093 Rose Gold <sup>NEW!</sup>	Please see the respective product matrix for all available code references.



## Buttons, Fasteners & Zippers

1791/120

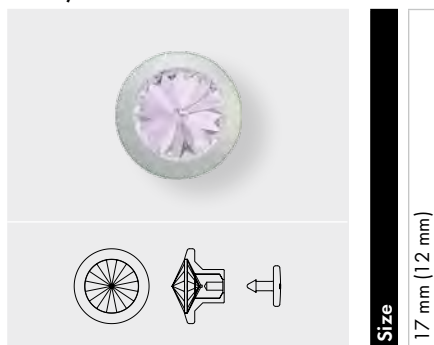

Size

17 mm (12 mm)

### Color of Casing

081 Gold

082 Silver

086 Gun Metal

093 Rose Gold NEW!

### Colors

#### Plain Colors

Smoky Mauve F (265) NEW!

## Crystal Buttons & Jeans Buttons

1792/100

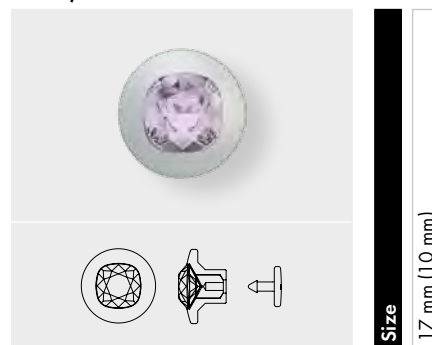

Size

17 mm (10 mm)

### Color of Casing

081 Gold

082 Silver

086 Gun Metal

093 Rose Gold NEW!

### Colors

#### Plain Colors

Smoky Mauve F (265) NEW!

## Buttons, Fasteners & Zippers

## Crystal Fine Rocks Jeans Button

### ARTICLE EXPLANATION

1795/140 Crystal Fine Rocks Jeans Button

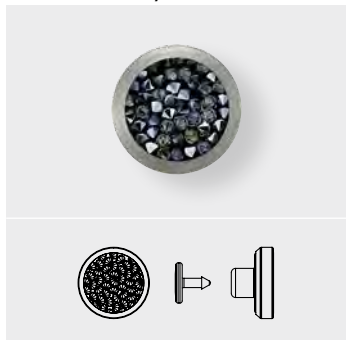

M 24 PCS

100%

1795/140

M

100%

Article number

Minimum Order Quantity in pieces (PCS)

Documentation size in %

### ORDERING EXAMPLE & PRODUCT VARIETY EXPLANATION

1795/140	082	010	001 AB
Article number	Color of casing	Color of film of the Fine Rocks Motif	Color of Fine Rocks Motif
	081 Gold	Please see the respective product matrix for all available code references.	Please see the respective product matrix for all available code references.
	082 Silver		
	086 Gun Metal		
	093 Rose Gold <small>NEW!</small>		

1795/140 Crystal Fine Rocks Jeans Button <sup>NEW!</sup>

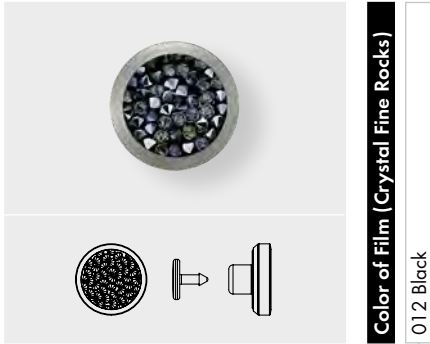



**Color of Film (Crystal Fine Rocks)**  
012 Black

- Color of Casing**
- 081 Gold
- 082 Silver
- 093 Rose Gold
- 086 Gun Metal
- 093 Rose Gold <sup>NEW!</sup>
- Color**
- Plain Color**
- Jet (280)
- Opal Colors**
- Chrysolite Opal (294)
- Cyclamen Opal (398)
- Rose Water Opal F (395)
- White Opal F (234)
- Crystal Effects**
- Transparent Effects**
- Crystal Aurore Boreale (001 AB)
- Crystal Bermuda Blue (001 BBL)
- Crystal Moonlight (001 MOL)
- Crystal Red Magma (001 REDM)
- Crystal Silver Shade (001 SSHA)
- Metallic Effects**
- Crystal Chrome (001 CHRM)

**APPLICATION ADVICE****Tools for fly press**

The Crystal Fine Rocks Jeans Button can be easily applied by using a fly press. The tools for the Chessboard Button are used for the application:

	Art. 1795/140 
<b>UPPER DIE</b>	Art. 9060/009 
<b>SPARE PART FOR UPPER DIE (INLAY)</b>	Art. 9060/018 

<b>LOWER DIE</b>	Art. 9060/016 
<b>THREAD ADAPTER</b>	Art. 9060/014* 
<b>CHANGING PIN</b>	Art. 9060/015 

\* When using upper die art. 9060/009, please employ the specially developed thread adapter art. 9060/014.

**Application**

1 Place the top part of the Jeans Button in the upper die.



2 Place the arrow pin in the lower die.



3 Position the carrier material and apply. Regulate the offset/pressure using the adjustable stop.

**CARE INSTRUCTIONS**

The care instructions for the Crystal Fine Rocks Jeans Button are the same as those that apply to the Jeans Button assortment. For detailed information, please refer to the Application Manual and our business website [SWAROVSKI.COM/PROFESSIONAL](http://SWAROVSKI.COM/PROFESSIONAL).

1811/100



Size

12 mm (10 mm)

1811/120



Size

15 mm (12 mm)



1811/100  
1811/120

Color of Casing

081 Gold

082 Silver

086 Gun Metal

093 Rose Gold

NEW!

Colors

Plain Colors

 Smoky Mauve F (265)

NEW!



# Metal Trimmings

52 000



R	001-024	
SS	SS 18	
M	05 M	100%

52 001 \*

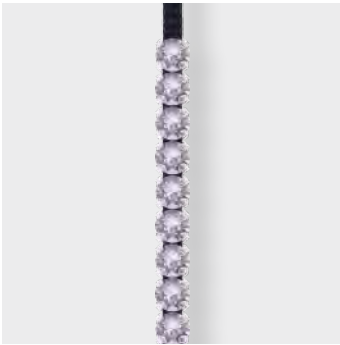

R	001	
SS	SS 18	
M	10 M	100%

52 500



R	001-024	
SS	PP 24	
M	05 M	100%

52 501 \*\*

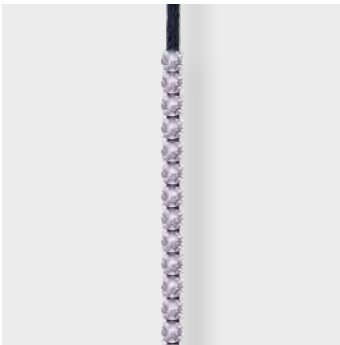

R	001	
SS	PP 24	
M	10 M	100%

# Chaton Bandings



52 000  
52 001 \*

### Colors

#### Plain Colors

NEW! Smoky Mauve F (265)

<b>Color of Thread / Net-edge</b>	012 / 112 / 212 Black
	022 / 122 / 222 White
<b>Color of Casing</b>	081 Gold
	082 Silver
	086 Gun Metal
	093 Rose Gold <small>NEW!</small>

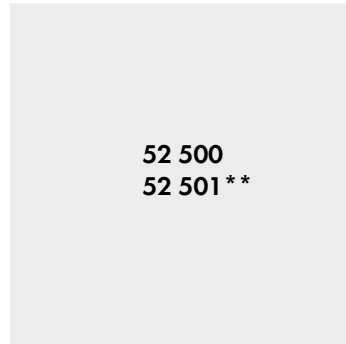

52 500  
52 501 \*\*

### Colors

#### Plain Colors

NEW! Smoky Mauve F (265)

<b>Color of Thread / Net-edge</b>	012 / 112 / 212 Black
	022 / 122 / 222 White
<b>Color of Casing</b>	081 Gold
	082 Silver
	086 Gun Metal
	093 Rose Gold

\* Art. 52 001 is not available with net-edge. When ordering one row with net-edge, art. 52 000 is to be used.

\*\* Art. 52 501 is not available with net-edge. When ordering one row with net-edge, art. 52 500 is to be used.

# Metal Trimmings

55 000



R	001-024	
SS	SS 20	
M	05 M	100%

55 001 \*



R	001	
SS	SS 20	
M	10 M	100%

# Flat Back Bandings

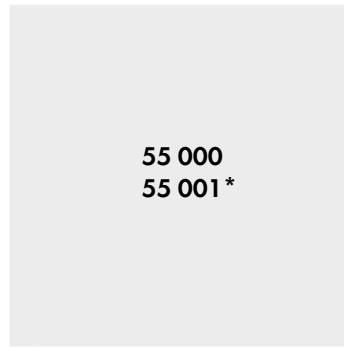

## Colors

### Plain Colors

	Smoky Mauve F (265)
--	---------------------

<b>Color of Thread / Net-edge</b>	012 / 112 / 212 Black
	022 / 122 / 222 White
<b>Color of Casing</b>	081 Gold
	082 Silver
	086 Gun Metal
	093 Rose Gold <sup>NEW!</sup>

\* Art. 55 001 is not available with net-edge. When ordering one row with net-edge, art. 55 000 is to be used.

Flat Back Banding interacts beautifully with the light and responds to our demand for natural shine in which matt and sparkling surfaces playfully alternate.

## ARTICLE EXPLANATION

### 55 300 Flat Back Banding <sup>NEW!</sup>

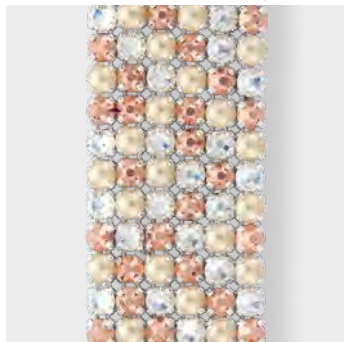

<b>R</b> 001-024	
<b>SS</b> SS 16	
<b>M</b> 05 M	<b>100%</b>

### 55 301 Flat Back Banding <sup>NEW!</sup>

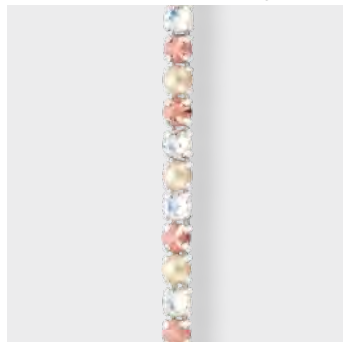

<b>R</b> 001	
<b>SS</b> SS 16	
<b>M</b> 05 M	<b>100%</b>

55 300	R	SS	M	100%
Article number	Number of rows	Stone size	Minimum order quantity in meters (M)	Documentation size in %
	This article is available from 1 to 24 rows.			
55 301	R	SS	M	100%
Article number	Number of rows	Stone size	Minimum order quantity in meters (M)	Documentation size in %
	This article is available in 1 row.			

## ORDERING EXAMPLE & PRODUCT VARIETY EXPLANATION

53 000 01	004	012	082	001
Article number	3-digit code for number of rows	Color of thread (without net-edge, on 1 side/2 sides):	Color of casing	Color of crystals
01 1 color/stone		012 Black	081 Gold	Please see the respective product matrix for all available code references.
02 2 colors/stone		(without net-edge)	082 Silver	
03 3 colors/stone		022 White	086 Gun Metal	
		(without net-edge)		
		112 Black (on 1 side)		
		212 Black (on 2 sides)		
		122 White (on 1 side)		
		222 White (on 2 sides)		

Please note: Articles with 1 row are only available with one or two side net-edge. The articles 52 001, 52 501, 55 001 and 55 501, however, can be ordered without net-edge.

**AVAILABLE COMBINATIONS**

Flat Back Banding is available in stone size SS 16 and in three different stones types: **Crystal, Ceramics** and **Cabochons**.\* Mix all three stone types and their respective colors to create a unique new look.

**55 300 03, 55 301 03**



**Choose from the three different stone types and their available colors to create your personal mix and get a unique look. Here are some examples of possible combinations:**

- SS300/03 004 012 001(C) 291 001 AB 001 ROGL
- SS300/03 004 012 001 AB 001 001(C) 291
- SS300/03 004 012 001 001(C) CHRMV 657

**55 300 02, 55 301 02**

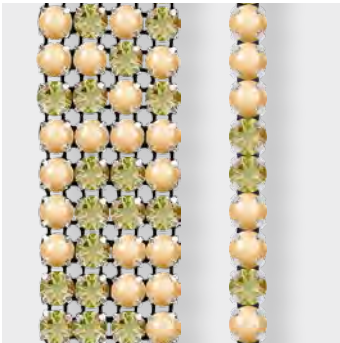

**Examples for the two-component combination:**

- SS300 02/004 012 001 LISH 266
- SS300 02/004 012 001 LUMG 001(C) GSHA

**55 300 01, 55 301 01**

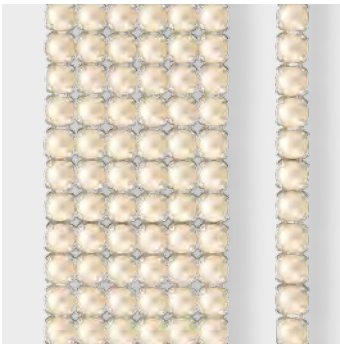

**1 component**

- Choose one stone type in color
- SS300 01/004 022 001(C) 291

Please note that in the three- and two-stone mix the stones will be placed randomly. Samples are available from 0.5 m - 2.0 m.

\* The color code for Cabochons includes a (C)



## AVAILABLE OPTIONS WITH NET-EDGE

All Chaton & Flat Back Bandings can be ordered with net-edge. This option can be added on one side or on both sides of the banding. Please see the respective product matrix for all available options.

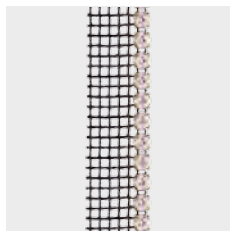

112  
Black net-edge  
on 1 side

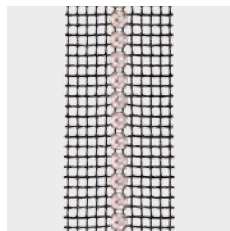

212  
Black net-edge  
on 2 sides

## AVAILABLE COMBINATIONS OF THREAD & CASING

Chaton and Flat Back Bandings are available in three different casing colors and can be combined with two different thread/net-edge colors. Please see the respective product matrix for all available options.



112 081  
Black thread,  
gold casing



122 081  
White thread,  
gold casing



112 082  
Black thread,  
silver casing

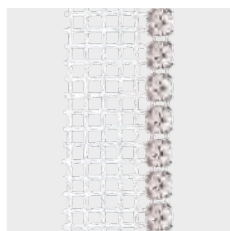

122 082  
White thread,  
silver casing



112 086  
Black thread,  
gun metal casing

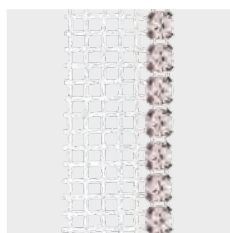

122 086  
White thread,  
gun metal casing

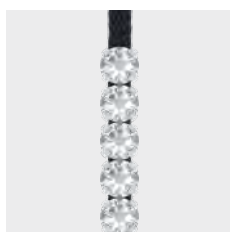

012 082  
Black

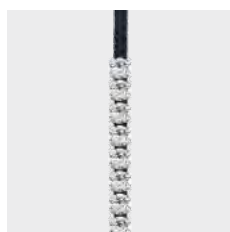

012 082  
Black

55 300 55 301		Color of Thread / Net-edge		Color of Casing			
		012 / 112 / 212 Black	022 / 122 / 222 White	081 Gold	082 Silver	086 Gun Metal	093 Rose Gold
<b>COLOR OF CRYSTALS</b>							
<b>Crystal</b>							
Crystal F (001)		■	■	■	■	■	■
<b>Colors</b>							
<b>Plain Colors</b>							
Black Diamond F (215)		■	■	■	■	■	■
Dark Moss Green F (260)		■	■	■	■	■	■
Denim Blue F (266)		■	■	■	■	■	■
Fuchsia F (502)		■	■	■	■	■	■
Greige F (284)		■	■	■	■	■	■
Jet F (280)		■	■	■	■	■	■
Light Amethyst F (212)		■	■	■	■	■	■
Light Colorado Topaz F (246)		■	■	■	■	■	■
Light Silk F (261)		■	■	■	■	■	■
Light Turquoise F (263)		■	■	■	■	■	■
Smoky Mauve F (265) <small>NEW!</small>		■	■	■	■	■	■
Rose Peach F (262)		■	■	■	■	■	■
Siam F (208)		■	■	■	■	■	■
Smoked Topaz F (220)		■	■	■	■	■	■
Tangerine F (259)		■	■	■	■	■	■
Vintage Rose F (263)		■	■	■	■	■	■
<b>Opal Colors</b>							
Caribbean Blue Opal F (394)		■	■	■	■	■	■
<b>Crystal Effects</b>							
<b>Transparent Effects</b>							
Crystal AB F (001 AB)		■	■	■	■	■	■
Crystal Antique Pink F (001 ANTP)		■	■	■	■	■	■
Crystal Blue Shade F (001 BLSH)		■	■	■	■	■	■
Crystal Golden Shadow F (001 GSHA)		■	■	■	■	■	■
Crystal Lilac Shadow F (001 LISH)		■	■	■	■	■	■
Crystal Luminous Green F (001 LUMG)		■	■	■	■	■	■
Crystal Silver Night F (001 SINI)		■	■	■	■	■	■
Crystal Silver Shade F (001 SSHA)		■	■	■	■	■	■
<b>Metallic Effects</b>							
Crystal Dorado F (001 DOR)		■	■	■	■	■	■
Crystal Iridescent Green F (001 IRIG)		■	■	■	■	■	■
Crystal Rose Gold F (001 ROGL)		■	■	■	■	■	■
<b>Color Effects</b>							
<b>Metallic Effects</b>							
Jet Hematite F (280 HEM)		■	■	■	■	■	■

55 300 55 301		Color of Thread / Net-edge		Color of Casing			
		012 / 112 / 212 Black	022 / 122 / 222 White	081 Gold	082 Silver	086 Gun Metal	093 Rose Gold <small>NEW!</small>
<b>COLOR OF CABOCHONS</b>							
<b>Plain Colors</b>							
● Jet (280(C))	■	■	■	■	■	■	■
<b>Crystal Pearl Colors</b>							
● Crystal Bronze Pearl (001(C) 295)	■	■	■	■	■	■	■
● Crystal Creampearl (001(C) 291)	■	■	■	■	■	■	■
● Crystal Dark Grey Pearl (001(C) 617)	■	■	■	■	■	■	■
● Crystal Rosaline Pearl (001(C) 294)	■	■	■	■	■	■	■
● Crystal White Pearl (001(C) 650)	■	■	■	■	■	■	■
<b>Gemcolors</b>							
● Crystal Jade Pearl (001(C) 715)	■	■	■	■	■	■	■
● Crystal Pink Coral Pearl (001(C) 716)	■	■	■	■	■	■	■
● Crystal Red Coral Pearl (001(C) 718)	■	■	■	■	■	■	■
● Crystal Turquoise Pearl (001(C) 709)	■	■	■	■	■	■	■
<b>Crystal Effects</b>							
<b>Transparent Effects</b>							
● Crystal Golden Shadow (001(C) GSHA)	■	■	■	■	■	■	■
● Crystal Nacre (001(C) 191)	■	■	■	■	■	■	■
<b>Metallic Effects</b>							
● Crystal Chrom V (001(C) CHRMV)	■	■	■	■	■	■	■
<b>Color Effects</b>							
<b>Metallic Effects</b>							
● Jet Hematite (280(C) HEM)	■	■	■	■	■	■	■
<b>COLOR OF CERAMICS</b>							
● Marbled Black (653)	■	■	■	■	■	■	■
● Marbled Blue (654)	■	■	■	■	■	■	■
● Marbled Light Grey (657)	■	■	■	■	■	■	■
● Marbled Terracotta (655)	■	■	■	■	■	■	■
● Marbled Yellow (652)	■	■	■	■	■	■	■

# Metal Trimmings

55 500



R	001-024	
SS	SS 12	
M	10 M	100%

55 501\*



R	001	
SS	SS 12	
M	10 M	100%

# Flat Back Bandings

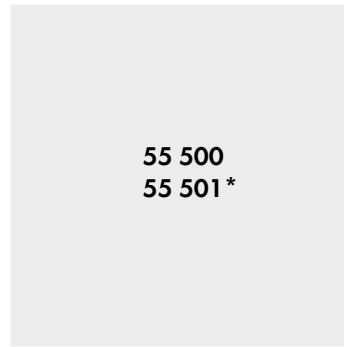

## Colors

### Plain Colors

	Smoky Mauve F (265)
--	---------------------

<b>Color of Thread / Net-edge</b>	012 / 112 / 212 Black
	022 / 122 / 222 White
<b>Color of Casing</b>	081 Gold
	082 Silver
	086 Gun Metal
	093 Rose Gold <sup>NEW!</sup>

\* Art. 55 501 is not available with net-edge. When ordering one row with net-edge, art. 55 500 is to be used.

# Metal Trimmings

# Metal Components

# Rivets

## 53 001 Rivets



SS SS 29  
M 500 PCS 100%

## 53 005 Rivets

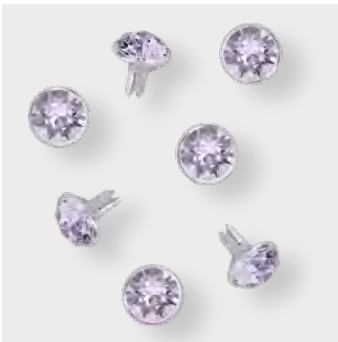

SS SS 34  
M 500 PCS 100%

## 53 006 Rivets



SS SS 39  
M 300 PCS 100%

## 53 008 Rivets

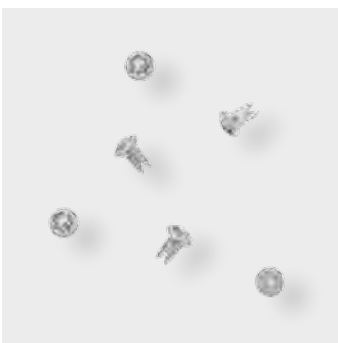

SS PP 24  
M 500 PCS 100%

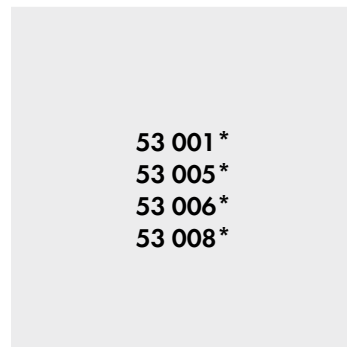

Color of Casing	NEW!
081 Gold	
082 Silver	
086 Gun Metal	
093 Rose Gold	

### Colors

#### Plain Colors

Smoky Mauve F (265) NEW!

#### Crystal Effects

#### Transparent Effects

Crystal Paradise Shine F (001 PARSH) NEW!

\* For respective Back Parts please refer to the chapter 'Metal Trimmings' in the Swarovski Crystal Collection 2014 (page 605).

**53 500** Square Rivets



SS 4 mm  
M 500 PCS 100%

**53 501** Square Rivets

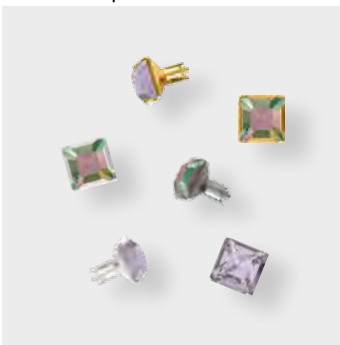

SS 6 mm  
M 300 PCS 100%

**53 502** Square Rivets



SS 8 mm  
M 300 PCS 100%

53 500 53 501 53 502	Color of Casing	081 Gold	082 Silver	086 Gun Metal	093 Rose Gold <small>NEW!</small>
	Colors				
	Plain Colors				
	Smoky Mauve F (265) <small>NEW!</small>	■	■	■	■
Crystal Effects					
Transparent Effects					
Crystal Paradise Shine F (001 PARSH) <small>NEW!</small>	■	■	■	■	

\* For respective Back Parts please refer to the chapter 'Metal Trimmings' in the Swarovski Crystal Collection 2014 (page 605).

# Metal Trimmings

# Metal Components

# Rose Montées

## 53 100 Rose Montées



SS SS 12  
M 1,440 PCS 100%

## 53 102 Rose Montées



SS SS 16  
M 1,440 PCS 100%

## 53 200 Chaton Montées



SS PP 31  
M 1,440 PCS 100%

## 53 203 Chaton Montées

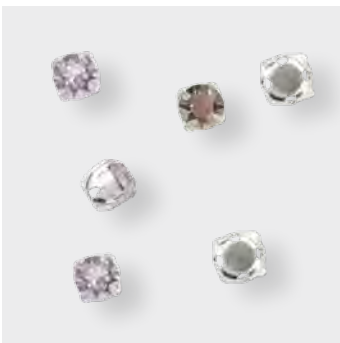

SS SS 29  
M 720 PCS 100%

53 100  
53 102

**Color of Casing**

- 082 Silver
- 086 Gun Metal
- 093 Rose Gold NEW!

**Colors**

**Plain Colors**

- Smoky Mauve F (265) NEW!

**Crystal Effects**

**Transparent Effects**

- Crystal Paradise Shine F (001 PARSH) NEW!

53 200  
53 203

**Color of Casing**

- 082 Silver
- 086 Gun Metal
- 093 Rose Gold NEW!

**Colors**

**Plain Colors**

- Smoky Mauve F (265) NEW!

**Crystal Effects**

**Transparent Effects**

- Crystal Paradise Shine F (001 PARSH) NEW!

# Metal Trimmings

# Metal Components

# Rose Pins

## 53 301 Rose Pins



SS SS 10  
M 1,440 PCS 100%

## 53 302 Rose Pins



SS SS 16  
M 1,440 PCS 100%

## 53 303 Rose Pins

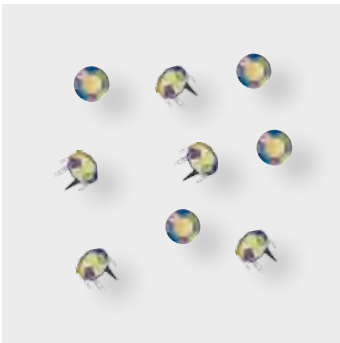

SS SS 20  
M 720 PCS 100%

## 53 304 Rose Pins

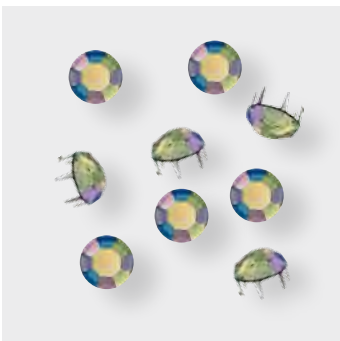

SS SS 34  
M 288 PCS 100%

53 301  
53 302  
53 303  
53 304

Color of Casing  
088 Stainless Steel

Crystal Effects

Transparent Effects

Crystal Paradise Shine F (001 PARSH) NEW!



# Crystal Mesh

# Crystal Mesh Standard, Crystal Mesh Metallisée

40 000

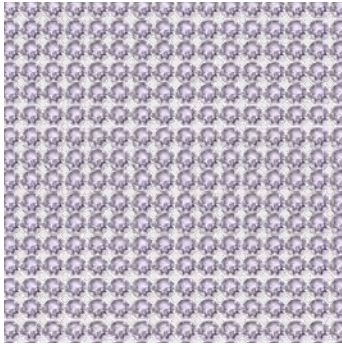

SH 100	
S ~500x200	
SS PP 21	
M 1 SH	100%

40 001



R 002-033	
SS PP 21	
M 10 M	100%

40 200

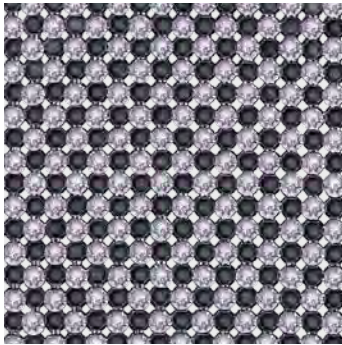

SH 100	
S ~500x200	
SS PP 21	
M 1 SH	100%

40 201

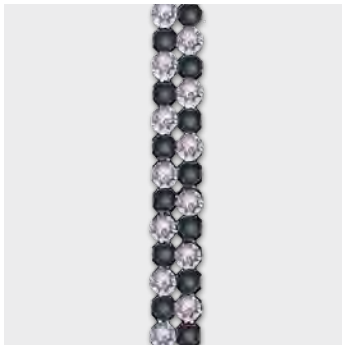

R 002-033	
SS PP 21	
M 10 M	100%

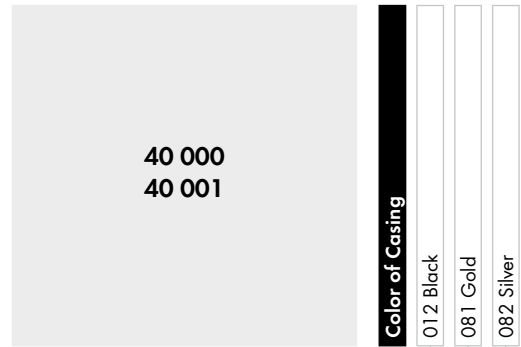

Colors

Plain Colors

Smoky Mauve F (265)

Color of Casing

012 Black

081 Gold

082 Silver

NEW!

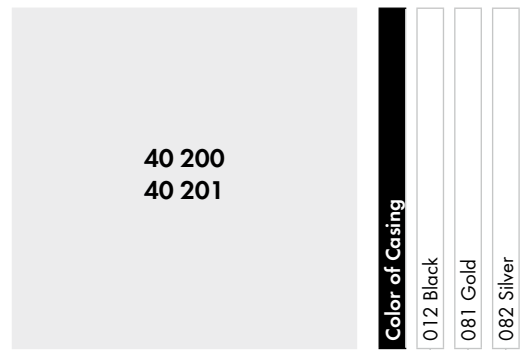

Colors

Plain Colors

Smoky Mauve F (265)

Color of Casing

012 Black

081 Gold

082 Silver

NEW!

# Crystal Mesh

40 400

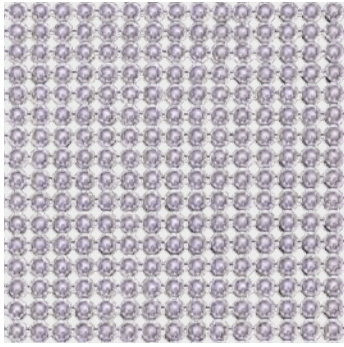

SH	100	
S	~500x200	
SS	PP 14	
M	1 SH	100%

40 401

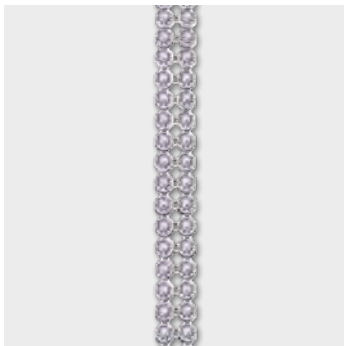

R	002-033	
SS	PP 14	
M	10 M	100%

# Crystal Aerial Mesh

40 400  
40 401

Color of Casing

012 Black

081 Gold

082 Silver

**Colors**

**Plain Colors**

Smoky Mauve F (265)

NEW!

With its luxurious use of brilliant crystals, the Crystal Fine Mesh is the perfect addition to the Crystal Mesh family. It consists of XILION chatons as small as size PP 9, making it extremely smooth and graceful.

**ARTICLE EXPLANATION**

**40 600** <sup>NEW!</sup>



<b>SH</b>	100
<b>S</b>	~500x200
<b>SS</b>	PP 9
<b>M</b>	1 SH <b>100%</b>

**40 601** <sup>NEW!</sup>

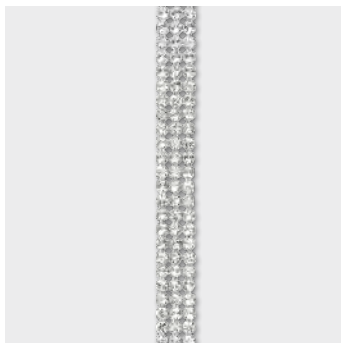

<b>R</b>	003-033
<b>SS</b>	PP 9
<b>M</b>	10 M <b>100%</b>

<b>40 600</b>	<b>SH</b>	<b>S</b>	<b>SS</b>	<b>M</b>	<b>100%</b>
Article number	Sheet	Sheet size in mm	Stone size	Minimum order quantity in sheets (SH)	Documentation size in %
<b>40 601</b>	<b>R</b>	<b>SS</b>	<b>M</b>	<b>100%</b>	
Article number	Number of rows	Stone size	Minimum order quantity in meters (M)	Documentation size in %	

**ORDERING EXAMPLE & PRODUCT VARIETY EXPLANATION**

<b>40 600</b>	<b>100</b>	<b>082</b>	<b>001</b>	<b>NOHF</b>
Article number	100 Standard Sheet (500x200 mm)	Color of casing 081 Gold* 082 Silver*	Color of crystals Please see the respective product matrix for all available code references.	Hotfix Technology HF With Hotfix glue NOHF Without Hotfix glue
<b>40 601</b>	<b>003</b>	<b>082</b>	<b>001</b>	<b>HF</b>
Article number	3-digit code for number of rows	Color of casing 081 Gold* 082 Silver*	Color of crystals Please see the respective product matrix for all available code references.	Hotfix Technology HF With Hotfix glue NOHF Without Hotfix glue

\*Brass: 081 Gold, 082 Silver

# Crystal Mesh

40 600 <sup>NEW!</sup>



SH	100	
S	~500x200	
SS	PP 9	
M	1 SH	100%

40 601 <sup>NEW!</sup>



R	003-033	
SS	PP 9	
M	10 M	100%

# Crystal Fine Mesh

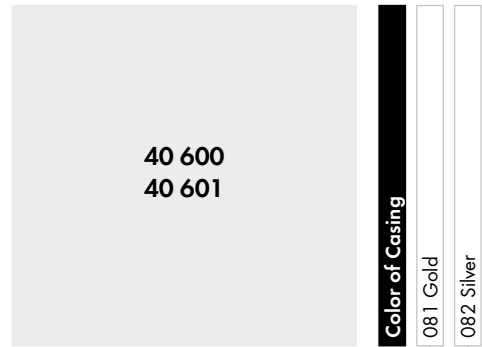

40 600 40 601		Color of Casing	
		081 Gold	082 Silver
<b>Crystal</b>			
<input type="checkbox"/>	Crystal F (001)	<input type="checkbox"/>	<input type="checkbox"/>
<b>Colors</b>			
<b>Plain Colors</b>			
<input type="checkbox"/>	Amethyst F (204)	<input type="checkbox"/>	<input type="checkbox"/>
<input type="checkbox"/>	Aquamarine F (202)	<input type="checkbox"/>	<input type="checkbox"/>
<input type="checkbox"/>	Black Diamond F (215)	<input type="checkbox"/>	<input type="checkbox"/>
<input type="checkbox"/>	Blue Zircon F (229)	<input type="checkbox"/>	<input type="checkbox"/>
<input type="checkbox"/>	Dark Moss Green F (260)	<input type="checkbox"/>	<input type="checkbox"/>
<input type="checkbox"/>	Dark Indigo F (288)	<input type="checkbox"/>	<input type="checkbox"/>
<input type="checkbox"/>	Denim Blue F (266)	<input type="checkbox"/>	<input type="checkbox"/>
<input type="checkbox"/>	Emerald F (205)	<input type="checkbox"/>	<input type="checkbox"/>
<input type="checkbox"/>	Fern Green F (291)	<input type="checkbox"/>	<input type="checkbox"/>
<input type="checkbox"/>	Fuchsia F (502)	<input type="checkbox"/>	<input type="checkbox"/>
<input type="checkbox"/>	Greige F (284)	<input type="checkbox"/>	<input type="checkbox"/>
<input type="checkbox"/>	Indian Pink F (289)	<input type="checkbox"/>	<input type="checkbox"/>
<input type="checkbox"/>	Jet F (280)	<input type="checkbox"/>	<input type="checkbox"/>
<input type="checkbox"/>	Jonquil F (213)	<input type="checkbox"/>	<input type="checkbox"/>
<input type="checkbox"/>	Light Amethyst F (212)	<input type="checkbox"/>	<input type="checkbox"/>
<input type="checkbox"/>	Light Colorado Topaz F (246)	<input type="checkbox"/>	<input type="checkbox"/>
<input type="checkbox"/>	Light Rose F (223)	<input type="checkbox"/>	<input type="checkbox"/>
<input type="checkbox"/>	Light Sapphire F (211)	<input type="checkbox"/>	<input type="checkbox"/>
<input type="checkbox"/>	Light Siam F (227)	<input type="checkbox"/>	<input type="checkbox"/>
<input type="checkbox"/>	Light Silk F (261)	<input type="checkbox"/>	<input type="checkbox"/>
<input type="checkbox"/>	Light Turquoise F (263)	<input type="checkbox"/>	<input type="checkbox"/>
<input type="checkbox"/>	Padparadscha F (542)	<input type="checkbox"/>	<input type="checkbox"/>
<input type="checkbox"/>	Peridot F (214)	<input type="checkbox"/>	<input type="checkbox"/>
<input type="checkbox"/>	Purple Velvet F (277)	<input type="checkbox"/>	<input type="checkbox"/>
<input type="checkbox"/>	Rose F (209)	<input type="checkbox"/>	<input type="checkbox"/>
<input type="checkbox"/>	Sapphire F (206)	<input type="checkbox"/>	<input type="checkbox"/>
<input type="checkbox"/>	Siam F (208)	<input type="checkbox"/>	<input type="checkbox"/>
<input type="checkbox"/>	Silk F (391)	<input type="checkbox"/>	<input type="checkbox"/>
<input type="checkbox"/>	Smoked Topaz F (220)	<input type="checkbox"/>	<input type="checkbox"/>
<input type="checkbox"/>	Sunflower F (292)	<input type="checkbox"/>	<input type="checkbox"/>
<input type="checkbox"/>	Tangerine F (259)	<input type="checkbox"/>	<input type="checkbox"/>
<input type="checkbox"/>	Tanzanite F (539)	<input type="checkbox"/>	<input type="checkbox"/>
<input type="checkbox"/>	Topaz F (203)	<input type="checkbox"/>	<input type="checkbox"/>
<input type="checkbox"/>	Vintage Rose F (319)	<input type="checkbox"/>	<input type="checkbox"/>
<b>Opal Colors</b>			
<input type="checkbox"/>	Palace Green Opal F (393)	<input type="checkbox"/>	<input type="checkbox"/>

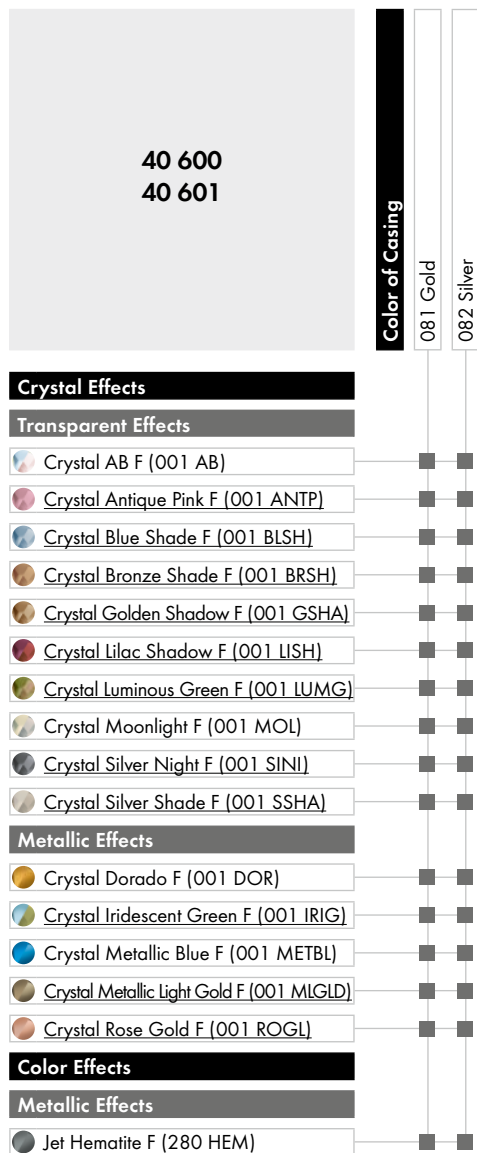

**APPLICATION ADVICE**

Crystal Fine Mesh can be easily applied using a standard heat press. The application parameters are the same as those that apply to Crystal Mesh (Standard, Aerial, and Metallisée).  
 Due to the tight structure of the Crystal Fine Mesh, it is not possible to sew on this product with a sewing machine, even not by hand. For detailed information, please refer to the Application Manual and our business website [SWAROVSKI.COM/PROFESSIONAL](http://SWAROVSKI.COM/PROFESSIONAL).

**CARE INSTRUCTIONS**

The care instructions for Crystal Fine Mesh are the same as those that apply to the Crystal Mesh assortment. For detailed information, please refer to the Application Manual and our business website [SWAROVSKI.COM/PROFESSIONAL](http://SWAROVSKI.COM/PROFESSIONAL).

ARTICLE EXPLANATION

37 E02 Catch-free Stretch Bracelet <sup>NEW!</sup>

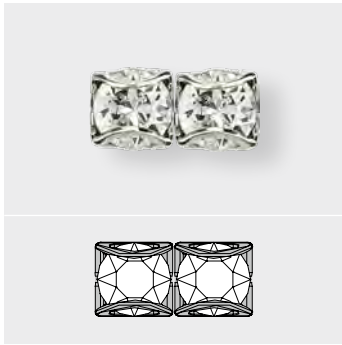

PP 32

Stone Size		Ring Configuration		Back Configuration		Stone Art. No.	Diameter
Code	Description	Code	Description	Code	Description	1088	55 mm
P32	PP 32	18	170 mm	C	Closed		

Back Configuration

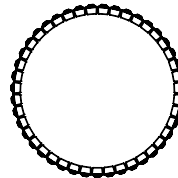

Closed

ORDERING EXAMPLE & PRODUCT VARIETY EXPLANATION

<b>1</b>	<b>37 E02</b>	<b>P32</b>	<b>18</b>	<b>C</b>	→
Material type	Base item number	Stone size	Ring configuration	Back configuration	
1 Brass		3-digit code from respective product matrix.	18 18 cm	C Closed	
<b>F1</b>	<b>G</b>	<b>1088</b>	<b>F</b>	<b>220</b>	
Stone pattern	Plating	Base item art. no.	Foiling	Color of crystal	
F1 Crystal/color/effect	Can be added at an additional charge	1088	F Foiled	Please see the respective color chart at the beginning of this chapter for all available code references.	
	<b>G</b> Gun Metal* <b>3</b> Gold* <b>H</b> Rhodium* <b>R</b> Rose Gold*				
	* Anti nickel allergenic				

37 E02

Size

PP 32

Crystal

Crystal F (001)

Colors

Plain Colors

Amethyst F (204)

Aquamarine F (202)

Black Diamond F (215)

Chrysolite F (238)

Denim Blue F (266)

Fuchsia F (502)

Jet F (280)

Light Colorado Topaz F (246)

Light Rose F (223)

Light Sapphire F (211)

Sapphire F (206)

Siam F (208)

Smoky Quartz F (225)

Tanzanite F (539)

Violet F (371)

Opal Colors

White Opal F (234)

Crystal Effects

Transparent Effects

Crystal AB F (001 AB)

Crystal Golden Shadow F (001 GSHA)

Crystal Lilac Shadow F (001 LISH)

Crystal Silver Shade F (001 SSHA)

---

**ARTICLE EXPLANATION**

The Chaton Sieve is an application aid especially developed for working with Swarovski Chatons. It perfectly supports the first step of the application process by bringing the Chatons into the necessary starting position.

**Key Features:**

- Allows easy handling of Chatons when arranging them for the application process
- Four cavity sizes on two sieves available for Swarovski Chatons of different sizes
- Perfect aid for gluing and for working with Ceralun™
- Light but durable material (polyurethane)

**Available Sizes**

Two sieves, both containing two differently structured surfaces, have been developed in order to match with Chatons of different sizes. To prevent confusion, each sieve is only available in one specific color.

When working with Chatons in sizes PP 2 – PP 20, the grey Chaton Sieve (art. 9030/001), with its narrow gaps, is the right choice. Work with sizes PP 2 – PP 8 on side one and turn the sieve over when wider gaps for sizes PP 9 – PP 20 are needed. With enough space for handling larger Chatons, the blue Chaton Sieve (art. 9030/002) is created for sizes PP 21 – SS 34. Side one is designed for working with Chatons in sizes PP 21 – PP 30, and side two is used for sizes PP 31 – SS 34.



**Chaton Sieve** for Chatons size PP 2-PP 20 (art. 9030/001)



**Chaton Sieve** for Chatons size PP 21-SS 34 (art. 9030/002)

---

**APPLICATION ADVICE**

- 1 Choose the right sieve type and side for your Chatons. Before starting, make sure the surface is clean by polishing it with lukewarm, soapy water and a soft brush. Dust can be removed with oil-free compressed air. Place some crystals onto the sieve.



- 2 Slightly shake the application aid and wipe over the crystals with glove-covered fingers. The majority of Chatons are automatically turned into the suitable position for gluing or working with Ceralun™ (table pointing upwards).



- 3 As a next step, the Chatons can easily be picked up from the sieve using tools like a wax stick, tweezers, or vacuum pick-up systems. In this way the Chaton Sieve, with its handy size, contributes in making work with small crystals much easier.



## EUROPE

For Austria, Germany, Switzerland, Benelux, Scandinavia, UK, Ireland, France, Spain, Portugal, Greece, Turkey, North Africa and Eastern Europe, please contact **SWAROVSKI INTERNATIONAL DISTRIBUTION AG** Triesen:

**SWAROVSKI international distribution ag**  
Dröschstrasse 15  
Postfach 567  
9495 Triesen  
Liechtenstein  
Tel: +423 399 5757  
Fax: +423 399 5750  
sp.infol@swarovski.com

**SWAROVSKI INT.LE D'ITALIA S.P.A. SOCIETA' A SOCIO UNICO**  
Via Giorgio Giulini n.3  
20123 Milano  
Italy  
Tel: +39 02 722601  
sp.IT@swarovski.com

**SWAROVSKI OOO**  
sp.infol@swarovski.com

**SWAROVSKI KRISTAL TIC.LTD.STI.**  
Abdi İpekçi Cad. Reasürans Han E Blok, No:57 Kat:5  
34367 Nişantaşı Şişli, Istanbul  
Turkey  
Tel: +90 (0) 212 225 44 29  
Fax: +90 (0) 212 225 27 99  
Swarovski.Turkey@swarovski.com

## MIDDLE EAST

**SWAROVSKI MIDDLE EAST FZE**  
P.O. Box 17128, Jebel Ali Free Zone  
Dubai  
United Arab Emirates  
Tel: +971 4 881 6562  
Fax: +971 4 881 5623  
info.sme@swarovski.com

**SWAROVSKI Dubai LLC**  
P.O. Box 117645  
Office No 107, Golf Park Building  
Garhoud, Dubai  
United Arab Emirates  
Tel: +971 4 2822027  
Fax: +971 4 2822866  
office.dubai@swarovski.com

**India Head Office:**  
**Swarovski India Pvt. Ltd.**  
1st floor, Tower C, DLF Building  
No.10,  
DLF Cyber City, Phase II  
Gurgaon, India  
Tel: +91 124 4698200  
+91 124 4698201  
konia.khanna@swarovski.com  
customer\_service.in@swarovski.com

**South India Contact Office:**  
Saleh Center  
No. 103, 1st Floor,  
18/9 Cunningham Road  
Bangalore – 560052  
India  
Tel: +91 80 30279870  
Fax: +91 80 30279866  
nirupama.nair@swarovski.com

## NORTH & SOUTH AMERICA

**SWAROVSKI CRYSTAL COMPONENTS LTDA.**  
Alameda Itu, 852 - 13º Andar  
01421-001 São Paulo – SP  
Brazil  
Tel: +55 11 3088 8821 (ext. 121)  
Fax: +55 11 3088 5976  
comercial.br@swarovski.com

**SWAROVSKI NORTH AMERICA LTD.**  
1 Kenney Drive, Cranston  
Rhode Island 02920-4400  
USA  
Tel: +1 401 463 5132  
Fax: +1 401 463 4707  
Toll free: 1 800 463 0849  
sp.sna@swarovski.com

**SWAROVSKI NORTH AMERICA LTD.**  
Los Angeles Showroom,  
California Mart  
110 East 9th Street, Suite B771  
Los Angeles, CA 90079-2827  
USA  
Tel: +1 213 489 2393  
Fax: +1 213 489 1961

**SWAROVSKI CRYSTAL S.A. DE C.V., MEXICO**  
Av. Ejército Nacional No. 579  
Piso 11, Local A  
Col. Granada  
Del. Miguel Hidalgo  
C.P. 11520  
México D.F.  
Tel/Fax: +5255 5545 4509

## ASIA

**SWAROVSKI HONG KONG LTD.**  
9th Floor, Fortis Centre,  
1063 King's Road  
Quarry Bay  
Hong Kong  
Tel: +852 2566 6301  
Fax: +852 2807 1902  
sp.infoHK@swarovski.com

**SWAROVSKI (GUANGZHOU) TRADING COMPANY LTD.**  
Rm 2401-2403, 24/F, Teemtower,  
Teemall  
208 Tianhe Road  
Guangzhou 510620  
China  
Tel: +86 20 3813 2188  
Fax: +86 20 3810 2278  
Toll Free: +86 400 880 1744  
sp.infoCN@swarovski.com

**SWAROVSKI (GUANGZHOU) TRADING COMPANY LTD.**  
Beijing Liaison Office  
Room 2001-2002,  
20/F, Tower B, Gemdale Plaza,  
No. 91, Jianguo Road,  
Chaoyang District,  
Beijing 100020  
China  
Tel: 010-65829773

**SWAROVSKI (GUANGZHOU) TRADING COMPANY LTD.**  
Shanghai Liaison Office  
Room 1602,  
The Headquarters Building  
No. 168, Xi Zang Road (M)  
Shanghai 200001  
China  
Tel: +86 21 2306 9945  
Fax: +86 21 6372 9180

**SWAROVSKI (GUANGZHOU) TRADING COMPANY LTD.**  
Dongguan Liaison Office  
Room 2202, Kingdom Plaza  
Central Road of East Downtown  
Dongguan City 523129  
China  
Tel: +86 769 2276 4723  
Fax: +86 769 2276 4708

**SWAROVSKI (GUANGZHOU) TRADING COMPANY LTD.**  
Qingdao Liaison Office  
Art & Technology Space  
Room No 1-506  
No. 63, Haier Road  
Qingdao 266061  
China  
Tel: +86 532 8099 9595  
Fax: +86 532 8099 9596

**SWAROVSKI (GUANGZHOU) TRADING COMPANY LTD.**  
Yiwu Liaison Office  
Room 8911, Yinlian International  
Business Building  
No. 1399, Chouzhou Road (North),  
Yiwu City, 322000  
Zhejiang Province  
China  
Tel: +86 579 8559 0903  
Fax: +86 579 8559 0707

**SWAROVSKI (GUANGZHOU) TRADING COMPANY LTD.**  
Shenzhen Liaison Office  
Room 13G, Tower C, Neo Building  
6009 Shennan Avenue,  
Futian District  
ShenZhen 518048  
China  
Tel: +86 755 23605750  
Fax: +86 755 23605735

**SWAROVSKI (GUANGZHOU) TRADING COMPANY LTD.**  
Chengdu Liaison Office  
Room 3908, Huamin Empire Plaza, 1  
Fuxing Street  
Jinjiang District, Chengdu, Sichuan  
China  
Tel: +86 28 8658 3506  
Fax: +86 28 8658 3535

# Swarovski Worldwide

## **Swarovski Taiwan LIMITED TAIWAN BRANCH**

3/F, No. 27, Chung-Shan North Road  
Section 1, Taipei 104  
Taiwan, R.O.C.  
Tel: +886 2 2100 2611  
Fax: +886 2 2100 2622  
sp.infotw@swarovski.com

## **SWAROVSKI SINGAPORE TRADING PTE. LTD.**

2, Alexandra Road  
#03-01 Delta House  
Singapore 159919  
Singapore  
Tel: +65 6661 6333  
Fax: +65 6274 8177  
sp.infosg@swarovski.com

## **PT CRYSTALLIZED ELEMENTS**

Cyber 2 Tower, 31st Floor Unit B  
JL. HR. Rasuna Said, Blok X5 No. 13  
Jakarta 12950  
Indonesia  
Tel: +62 21 2902 1451 / 52 / 53  
Fax: +62 21 2902 1454  
ptcrystallized.id@swarovski.com

## **Swarovski Singapore Pte. Ltd.**

(Vietnam Representative Office)  
Level 16 & 17, Gemadept Tower,  
6, Le Thanh Ton Street,  
Ward Ben Nghe, District 1,  
Ho Chi Minh City, Vietnam  
Tel: +84 8 62556768  
Fax: +84 8 62556801  
jeffrey.tan@swarovski.com

## **SWAROVSKI (THAILAND) LTD.**

849 Vorawat Building, 16th Floor,  
Room 1601 - 1602,  
Silom Road, Silom, Bangrak,  
Bangkok 10500  
Thailand  
Tel: +662 635 1990  
Fax: +662 635 1585  
keeratiya.poolsap@swarovski.com

## **SWAROVSKI KOREA LTD.**

BaekYoung Building 13F(SP)  
(6 Cheongdam-dong) 456 Dosan-  
daero, Gangnam-gu,  
Seoul, Korea 135-949  
Tel: +82 2 6930 9975  
Fax: +82 2 3416 0336  
Lucia.kim@swarovski.com

## **SWAROVSKI JAPAN LTD.**

Shinagawa Grand Central Tower, 3F  
2-16-4 Konan, Minato-ku  
Tokyo, 108-0075  
Japan  
Tel: +81 3 6718 2382  
Fax: +81 3 6718 2383  
sp.infoJP@swarovski.com

## **NEW ZEALAND**

### **SWAROVSKI INTERNATIONAL (NZ) LTD.**

9B Vega Place, Rosedale  
North Shore City 0632  
New Zealand  
Tel: +64 9970 3750  
Fax: +61 2 8345 7296  
elementsenquiries.sau@swarovski.com

## **AUSTRALIA**

### **SWAROVSKI INTERNATIONAL (AUSTRALIA) PTY. LTD.**

12 Primrose Avenue  
P.O. Box 185 (N.S.W 1445)  
Rosebery N.S.W. 2018  
Australia  
Tel: +61 2 8345 7200  
Fax: +61 2 9313 6506  
darren.solo@swarovski.com

## **SWAROVSKI COMMUNICATION & CREATIVE SERVICE CENTERS WORLDWIDE**

## **LONDON**

### **CORPORATE COMMUNICATIONS AND DESIGN SERVICES,**

### **SWAROVSKI CRYSTAL BUSINESS**

2nd Floor  
21 Sackville Street  
London, W1S 3DN  
United Kingdom  
Tel: +44 (0) 20 7255 8400  
Fax: +44 (0) 20 7255 8473  
www.swarovski.tv  
www.swarovskisparkles.com  
www.atelierswarovski.com  
www.swarovskicrystalpalace.com

## **LOS ANGELES**

### **SWAROVSKI NORTH AMERICA LTD.**

Los Angeles Showroom,  
California Mart  
110 E. 9th Street, Suite B771  
Los Angeles, CA 90079-2827  
USA  
Tel: +1 213 489 2393  
Fax: +1 213 489 1961

**Swarovski Corporate Communications Unit & Creative Services Center**  
8560 W. Sunset Blvd., Suite 200  
West Hollywood, CA 90069  
Los Angeles  
Tel: +1 310 652 0089 x3813  
Fax: +1 310 652 0951

## **DUBAI**

### **Swarovski Middle East FZE**

P. O. Box 17128, Jebel Ali Free Zone  
Dubai  
United Arab Emirates  
Tel: +971 4 881 6562  
Fax: +971 4 881 5623  
grace.downes@swarovski.com  
palak.bhati@swarovski.com

## **MILAN**

### **SWAROVSKI INT.LE D'ITALIA S.P.A.**

**SOCIETA' A SOCIO UNICO**  
Via Giorgio Giulini n.3  
20123 Milano  
Italy  
Tel: +39 02 722601  
stefania.fedeli@swarovski.com

## **NEW YORK**

### **Swarovski Creative Service Center**

29 West 57th Street, 8th Floor  
New York, NY 10019  
USA  
Tel: +1 212 935 4200  
Fax: +1 212 935 8800  
Toll free: 1 877 888 7980

## **PARIS**

### **Swarovski France S.A.S.**

15, Boulevard Poissonnière  
75002 Paris  
France  
Tel: +33 1 4476 1515  
cic.france@swarovski.com

## **SÃO PAULO**

### **Swarovski Crystal Components Ltda.**

Alameda Itu, 852-13° Andar  
01421-001 São Paulo – SP  
Brazil  
Tel: +55 11 3088 8821  
Fax: +55 11 3088 5976  
comercial.br@swarovski.com

## **WATTENS**

### **D. Swarovski KG**

6112 Wattens  
Austria  
Tel: +43 5224 500 3307  
Fax: +43 5224 501 3307  
sandra.oconnor@swarovski.com

## **SWAROVSKI TREND & APPLICATION CENTERS WORLDWIDE**

## **HONG KONG**

9th Floor, Fortis Centre,  
1063 King's Road  
Quarry Bay, Hong Kong  
Hong Kong  
Tel: +852 2566 6301  
Fax: +852 2807 1902

## **BEIJING**

Rm 2001-2002, 20 F, Tower B,  
Gemdale Plaza, No. 91,  
Jianguo Road, Chaoyang District  
Beijing 100020  
China  
Tel: 010-65829773

## **SHANGHAI**

Room 1602  
The Headquarters Building  
No. 168, Xi Zang Road (M)  
Shanghai 200001  
China  
Tel: +86 21 2306 9945  
Fax: +86 21 6372 9180

## **GUANGZHOU**

Rm 2401-2403, 24/F, Teemtower,  
Teemall  
208 Tianhe Road  
Guangzhou 510620  
China  
Tel: +86 20 3813 2188  
Fax: +86 20 3810 2278  
Toll Free: +86 400 880 1744

## **BANGKOK**

### **Swarovski (Thailand) Ltd.**

849 Vorawat Building, 16th Floor,  
Room 1601 - 1602,  
Silom Road, Silom, Bangrak  
Bangkok 10500  
Thailand  
Tel: +662 635 1990  
Fax: +662 635 1585  
sirikarn.ngamboosin@swarovski.com

## **TOKYO JAPAN TAC**

### **Swarovski Japan Ltd.**

Shinagawa Grand Central Tower, 3F  
2-16-4 Konan, Minato-ku  
Tokyo, 108-0075  
Japan  
Tel: +81 3 6718 2382  
Fax: +81 3 6718 2383  
sp.infoJP@swarovski.com

## **General Warning**

Loose crystals may present a small parts hazard to young children, particularly children under three years old. Depending on the size of the crystal and any attached material (such as glue, fabric, etc.), children may choke on, inhale, swallow, or insert the crystal into their noses. Magnetic products with crystal applications pose a particular risk of serious intestinal injury if ingested. The application techniques as stated in the Application Manual do not guarantee that crystals will not come loose. For each application, the manufacturer must determine whether the product meets the relevant requirements related to small parts hazards and assess any risk it may pose to small children. Failure to follow Swarovski's care instructions may result in damage to the crystal, which could pose a risk of laceration or other harm.

### **Warning for Crystal Tattoos**

Crystal Tattoos may be applied on healthy skin only. Do not adhere to eyes or on mucous membranes. Crystal Tattoos are not recommended for young children. Loose crystals may present a small parts hazard to young children, particularly children under three years old. If a crystal comes loose, depending on the size of the crystal, children may choke on, inhale, swallow, or insert the crystal into their noses.

### **Warning for Tableware**

Application of loose crystals to tableware presents a potential risk of aspiration, choking, swallowing, or tooth damage should crystals become loose. To reduce this risk, crystals should never be applied to any surface of tableware likely to come in contact with food or the mouth, and crystals should never be placed on any tableware intended for use by children. Tableware with crystals intended for decorative use only should be marked as such. To avoid dishwasher damage, tableware decorated with crystals should be washed by hand. The application techniques or suggestions in this manual do not guarantee that crystals will not come loose. For each application, the manufacturer must determine whether the product meets relevant requirements related to small parts hazards or use in food contact items and assess any risk it may pose to users. The use of crystals (which may contain restricted substances deemed hazardous under local laws) and adhesives on tableware is subject to legal restrictions in specific countries. The customer is fully responsible to comply with these country-specific provisions and shall defend, indemnify, and hold Swarovski harmless from any and all third-party claims based on product liability or otherwise relating to uses of Swarovski products and waives all its own claims against Swarovski.

### **Notice for Application on Packaging**

The use of crystal that may contain substances like lead, cadmium or hexavalent chromium, on packaging is subject to legal restrictions in specific countries, including but not limited in regard to the total content of substances based on the proportion between crystal mass to the remaining weight of packaging. The customer is fully responsible to comply with these country-specific provisions and to pass on this information to his customers.

## **Care Instructions**

Failure to follow Swarovski's care instruction may result in damage to the Swarovski product, which could pose a risk of laceration or other harm. Please be informed that all conventional laundering processes (household washing machine as well as professional dry-cleaning) have a considerable mechanical influence onto the garment, which is based on the rotation of the washing drum. The essential requirement for a safety laundering process is that the Swarovski products are properly applied without restrictions regarding the adherence of the Swarovski products. The bigger the size of the used Swarovski product is and the more Swarovski products are applied next to each other, the more a risk of damage has to be taken into consideration. Swarovski products are made of or incorporate crystal and therefore must be handled with due care! Generally, to best protect the Swarovski products from breaking we recommend the use of a soft washing bag and to fill up the washing drum. Turning inside out before washing and selection of a gentle washing program, plus the use of mild detergents are important prerequisites to safeguard the quality of our Swarovski products. Our care instructions based on DIN EN ISO 3758 list up all Swarovski product groups as overview so that each used Swarovski product still needs to be judged in terms of its cleaning suitability for the intended purpose and finished product by the customer. Swarovski's recommendations are given according to the current state of our knowledge and Swarovski's determination of the qualification as textile application product. The customer is therefore fully responsible to determine the cleaning process applicable to the finished product, taking the Swarovski care instructions as well as those of third party materials into account. The variety of shape, cut, surface effect, size and application weight respectively amount of used Swarovski products are decisive for the determination of the suitable cleaning process. To be entirely safe customers respectively dry-cleaners usually take off Sew-on Stones, Buttons, etc. of bigger size before cleaning and re-apply them afterwards.

### **Unsuitable Applications**

Crystals from Swarovski are intended for use in the fields of fashion, jewelry, accessories, textile products, and for interior décor. Due to their physical properties, crystals from Swarovski are unsuitable for other uses (e.g. gluing onto teeth, using crystals on or near mucous membranes, and other unsafe uses). The customer shall defend, indemnify and hold Swarovski harmless from any and all third-party claims based on product liability or otherwise relating to uses of Swarovski products purchased by the customer, and waives all its own claims.

### **Responsibility of User**

Any oral, written, or test-based advice that Swarovski provides regarding techniques for application of its products are recommendations based on Swarovski's current knowledge and the information provided by its suppliers. Such advice does not discharge the customer from carrying out its own tests of techniques it proposes to use and their suitability for the intended application. The application, use, and processing of these techniques and products are solely the user's responsibility.

## Credits:

**Classic**  
Crystal bracelet, Atelier Marangoni Collection.  
Source: Swarovski Corporate Archive

## Progressive

Dress by Kostas Murkudis.  
Orbite bracelet, Daniel Swarovski Paris Collection,  
FW 2004/05, Source: Swarovski Corporate Archive

## Romantic

Pants by Allude.  
Coat by Paul & Joe.  
Crystal fur cuff, Swarovski Fashion Collection.  
Source: Swarovski Corporate Archive

## Glamour

Dress by Augustin Teboul.  
Coat by Dawid Tomaszewski.  
Crystal Brooch, Fricaré Collection.  
Source: Swarovski Corporate Archive

## Valid from September 2014

Sys.No. 51 04935

Content is subject to change without notice.

Errors and misprints excepted.

Please note, the actual products may deviate from

the pictures in color and effect.

D. Swarovski Distribution GmbH, Swarovskistrasse 30,  
6112 Wattens, Austria

© 2014 D. Swarovski Distribution GmbH. All rights

reserved. Partial or total publication, transmission, copy

or other duplication of texts, graphics, pictures etc. which

are to be found in this publication is forbidden without

special consent by D. Swarovski Distribution GmbH.

Swarovski® is a registered trademark of Swarovski AG.

Art Direction by In the headroom

Photography by Daniela Midence, Markus Heumann,

Johannes Weiss, Thomas Trinkl, Mierswa-Kluska and

Athestia-Laserpoint

Illustrations by Petra Dufkova

Printed by RWF Frömel-Hechenleitner WerbeGes.m.b.H.,  
Volders/Austria